

**NOTICE DE MONTAGE
ASSEMBLY INSTRUCTIONS
MONTAGEANLEITUNG
ISTRUZIONI DI MONTAGGIO
INSTRUÇÕES DE MONTAGEM
INSTRUCCIONES DE MONTAJE
UPUTE ZA MONTAZU
MONTAJ TALIMATI**

14544 - 15128 - 15655

ARMARIO 2P. CORREDERA
WARDROBE 2 SLIDING DOORS
ARMOIRE 2P. COULISSANTS

ME
marckeric

MARCKERIC S.L.
C / ENLACE VEROLA S/N,
PC: 46430/SOLLANA / VALENCIA / SPAIN

EAN CODE

843517838283
8435178388940
8435178393111

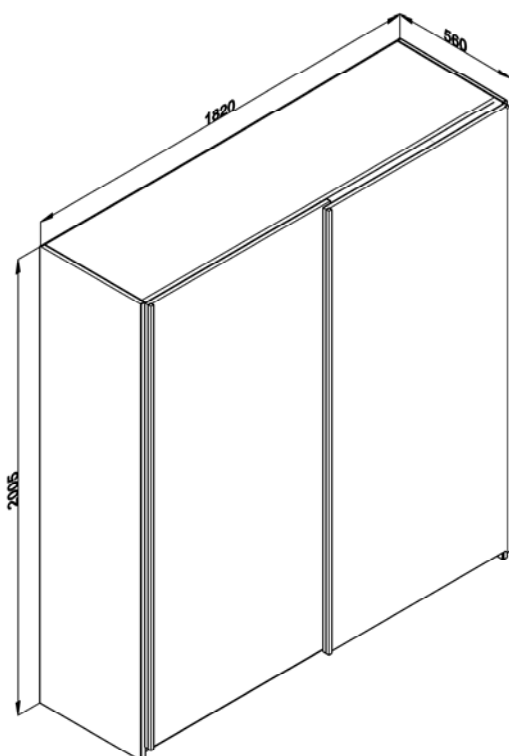

À MONTER SOI-MÊME

**AVANT DE COMMENCER, SE
REPORTER AUX CONSEILS
DE MONTAGE EN ANNEXE**

**BEFORE STARTING, REFER
TO THE ASSEMBLING ADVICE
IN ANNEX**

**VOR DER MONTAGE,
BEILIEGENDE ANWEISUNGEN
BEFOLGEN.**

**PRIMA DI COMINCIARE
LEGGETE LE ISTRUZIONI DI
MONTAGGIO**

**ANTES DE COMENÇAR, ADIAR
SE AOS CONSELHOS DE
MONTAGEM EM ANEXO**

**ANTES DE EMPEZAR
CONSULTE LOS CONSEJOS
PARA EL MONTAJE**

**PRIJE POČETKA MONTAŽE
MOLIMO PAŽLJIVO
PROČITAJTE UPUTE ZA
MONTAŽU**

**BASLAMADAN ÖNCE,
EKTEKI MONTAJ TALIMATLARINI
İNCELEYİNİZ**

| Caja Colis | Tamaño de la caja Dimensions colis | Peso bruto Poids brut | Peso neto Poids net |
|---------------|---------------------------------------|--------------------------|------------------------|
| 1/3 | 1993 x 927 x 47 | 46 Kg | 45,1 Kg |
| 2/3 | 2051 x 579 x 58 | 25 Kg | 24,3 Kg |
| 3/3 | 1949 x 516 x 90 | 42,5 Kg | 41,6 Kg |

"IMPORTANT- À CONSERVER POUR RÉFÉRENCE ULTÉRIEURE-LIRE ATTENTIVEMENT"



2h:50 min

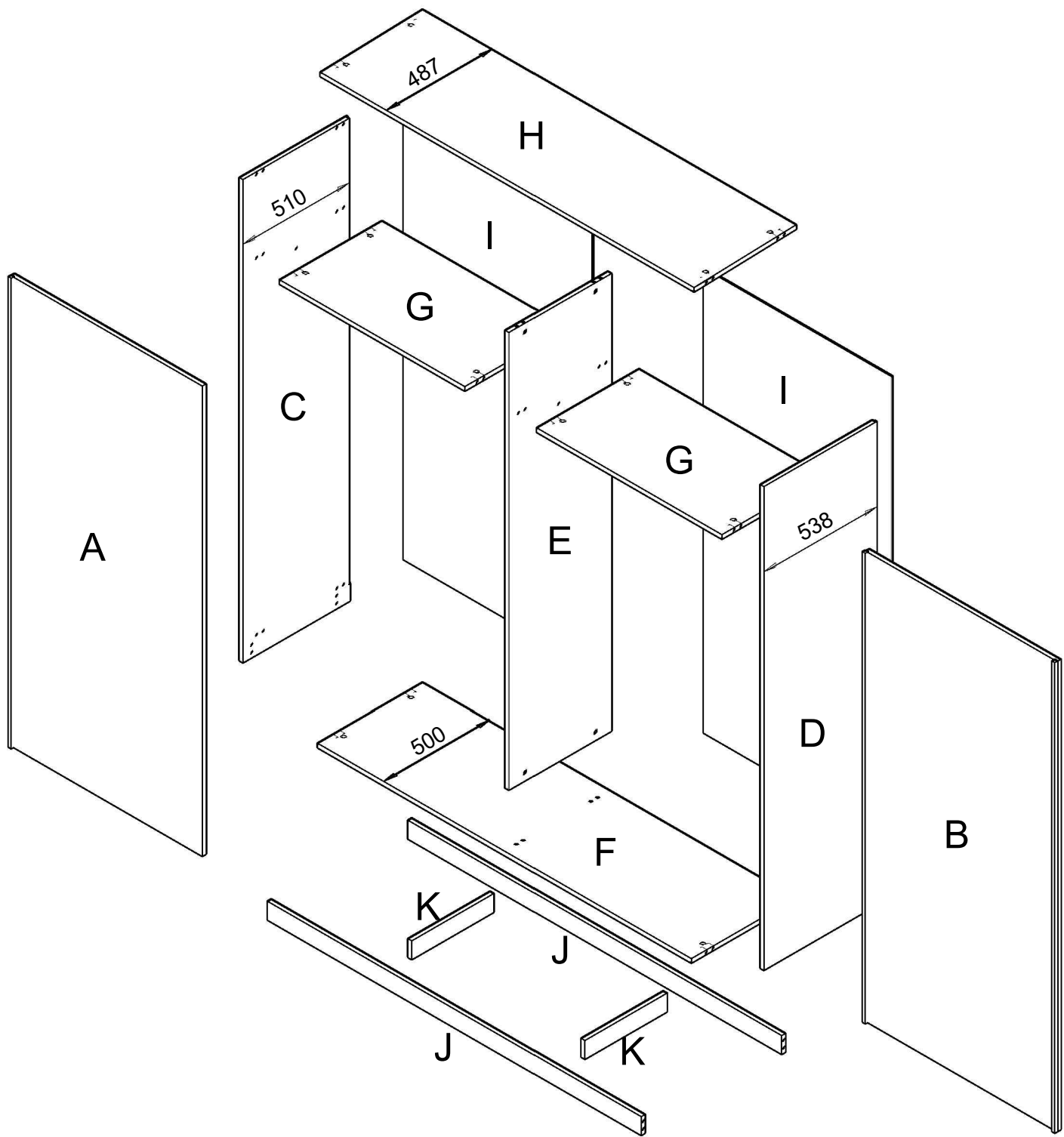

| CAJA/COLIS 1/3 | CAJA/COLIS 2/3 | CAJA/COLIS 3/3 |
|----------------|----------------|----------------|
|----------------|----------------|----------------|



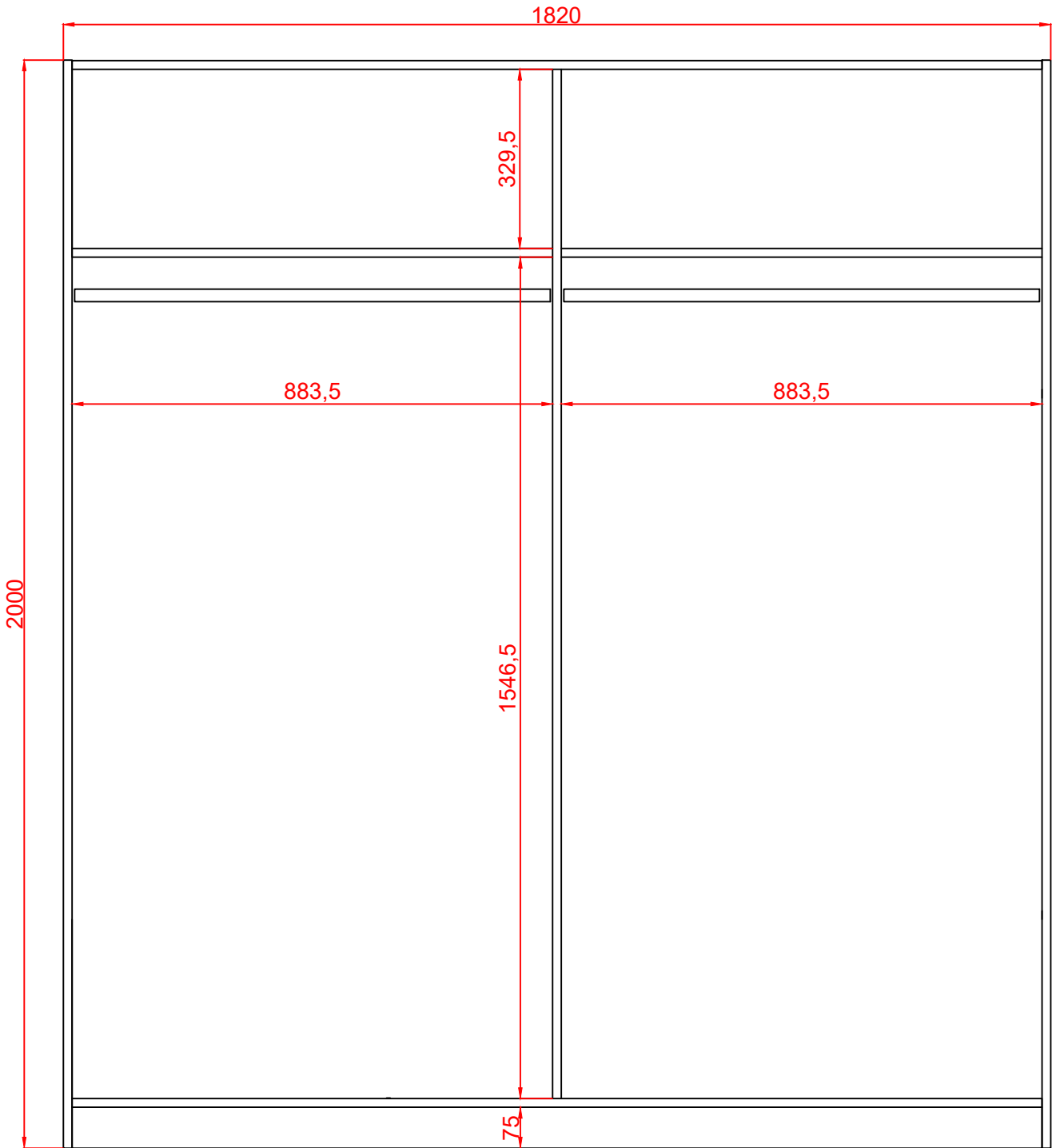

| | | |
|---------------|--------------|--------------|
| 1x PIECE - A | 1x PIECE - C | 1x PIECE - E |
| 1x PIECE - B | 1x PIECE - D | 1x PIECE - H |
| 2x PIECES - I | | 1x PIECE - F |

| | | |
|--|--|---------------|
| | | 2x PIECES - G |
| | | 2x PIECES - J |
| | | 2x PIECES - K |
| | | QUINCALLERIE |
| | | NOTICE DE |
| | | MONTAGE |



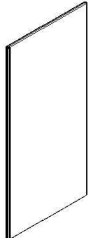
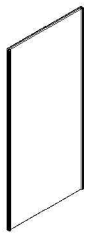
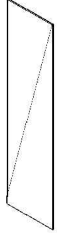

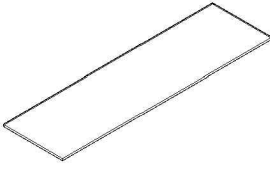
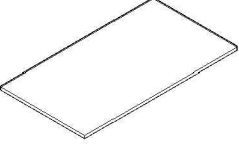
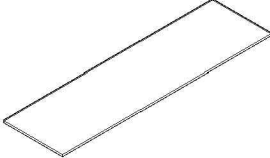
VISTA ALZADA

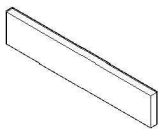
LISTADO DE PIEZAS - COMPOSANTS - PARTS LIST

| | |
|---|--|
| <p>(A)</p>  | <p>(B)</p>  |
| <p>1PU9015 1 Pc 914 x 1944 x 16</p> | <p>1PU9015 1 Pc 914 x 1944 x 16</p> |
| <p>(C)</p>  | <p>(D)</p>  |
| <p>1LA9336I 1 Pc 2000 x 510 x 16</p> | <p>1LA9336D 1 Pc 2000 x 538 x 16</p> |
| <p>(E)</p>  | <p>(F)</p>  |
| <p>1LA9337 1 Pc 1892 x 487 x 16</p> | <p>1SI9083 1 Pc 1783 x 500 x 16</p> |
| <p>(G)</p>  | <p>(H)</p>  |
| <p>1SI9085 2 Pc 883.5 x 487 x 16</p> | <p>1SI9084 1 Pc 1783 x 487 x 16</p> |
| <p>(I)</p>  | <p>(J)</p>  |
| <p>MTB1647 2 Pc 1922 x 899 x 3</p> | <p>1ZA8262 2 Pc 1783 x 75 x 16</p> |
| <p>(K)</p>  | |
| <p>1VA8703 2 Pc 390 x 75 x 16</p> | |

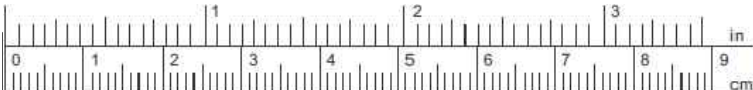
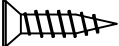
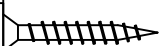

HERRAJES - QUINCALLERIE - HARDWARE

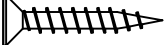
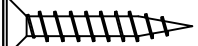
| | | | | | |
|---|---|--|---|---|---|
| ②  x78 MTR0420 3,5x15 | ③  x42 MTR0610 3x20 | ⑤  x42 MTR0641 6,3x11 | ⑦  x2 MTR0770 | ⑧  x16 MTR0715 | ⑮  x20 MTR0720 |
| ⑮  x28 MVA0090 | ⑰  x6 MTA0020 | ⑲  x6 MTR0541 | ⑳  x11 MGR0110 | ㉔  x1 MCL0090 | ㉗  x2 MBC0307 |
| ⑳  x4 MSP0060 | ㉓  x11 MTR0210 3x20 | ㉔  x2 MVA1958 TOR.FRENO | ㉘  x2 MVA1959 | ㉙  x1 MVA1957 PERFIL SUP. | ④  x1 MVA1958 PERFIL INF. |
| ④  x1 MVA1959 FRENO | ④  x2 MVA1959 PATIN INF.DER | ④  x2 MVA1959 PATIN INF.IZQ. | ④  x3 MVA1956 | ④  x2 MVA1956 SUP.DCHA | ④  x1 MVA1956 SUP.IZQ. |
| ④  x1 MVA1959 SUP.IZQ. | ④  x1 MTR0250 3,5x25 | | | | |



| | | | |
|---|---|--|--------|
| | |  | |
| ② |  | | 3,5x15 |
| ③ |  | | 3x20 |
| ⑤ |  | | 6,3x11 |
| ⑮ |  | | 8x30 |
| ㉓ |  | | 3x20 |
| ④ |  | | 3,5x25 |

1

"UTILISATION D'UNE COUVERTURE RECOMMANDÉE AFIN DE NE PAS ABIMER LES PIÈCES LORS DU MONTAGE"

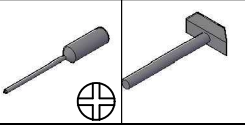
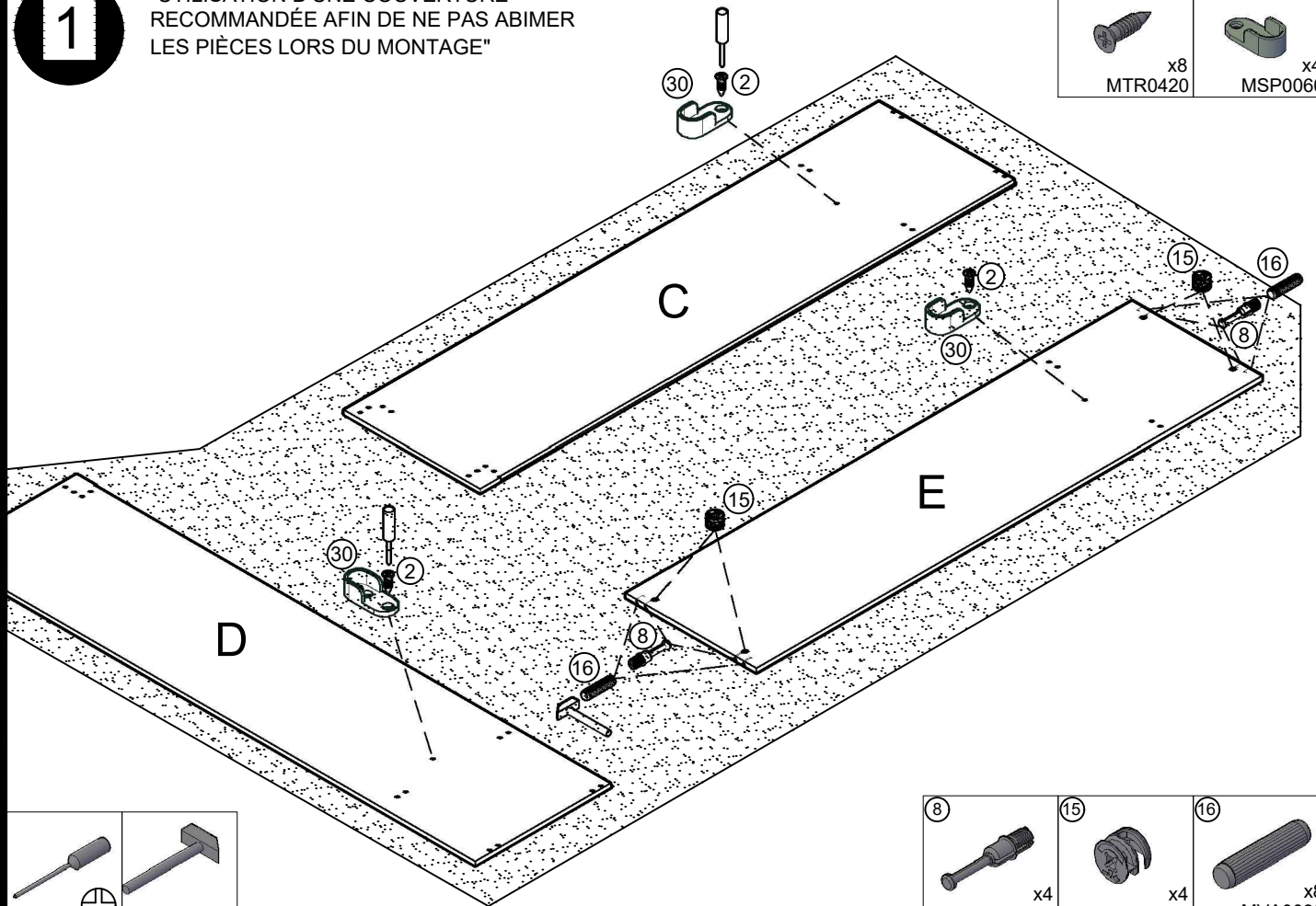





- | | | | |
|----------|--|-----------|--|
| 2 |  x8 MTR0420 | 30 |  x4 MSP0060 |
|----------|--|-----------|--|



- | | | | | | |
|----------|--|-----------|--|-----------|--|
| 8 |  x4 MTR0715 | 15 |  x4 MTR0720 | 16 |  x8 MVA0090 |
|----------|--|-----------|--|-----------|--|

2

"UTILISATION D'UNE COUVERTURE RECOMMANDÉE A FIN DE NE PAS ABIMER LES PIÈCES LORS DU MONTAGE"

- | | | | | | |
|----------|---|-----------|---|-----------|---|
| 8 |  x12 MTR0715 | 15 |  x16 MTR0720 | 16 |  x16 MVA0090 |
| 7 |  x2 MTR0770 | 2 |  x8 MTR0420 | 40 |  x1 MVA1958 |

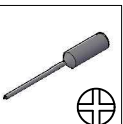
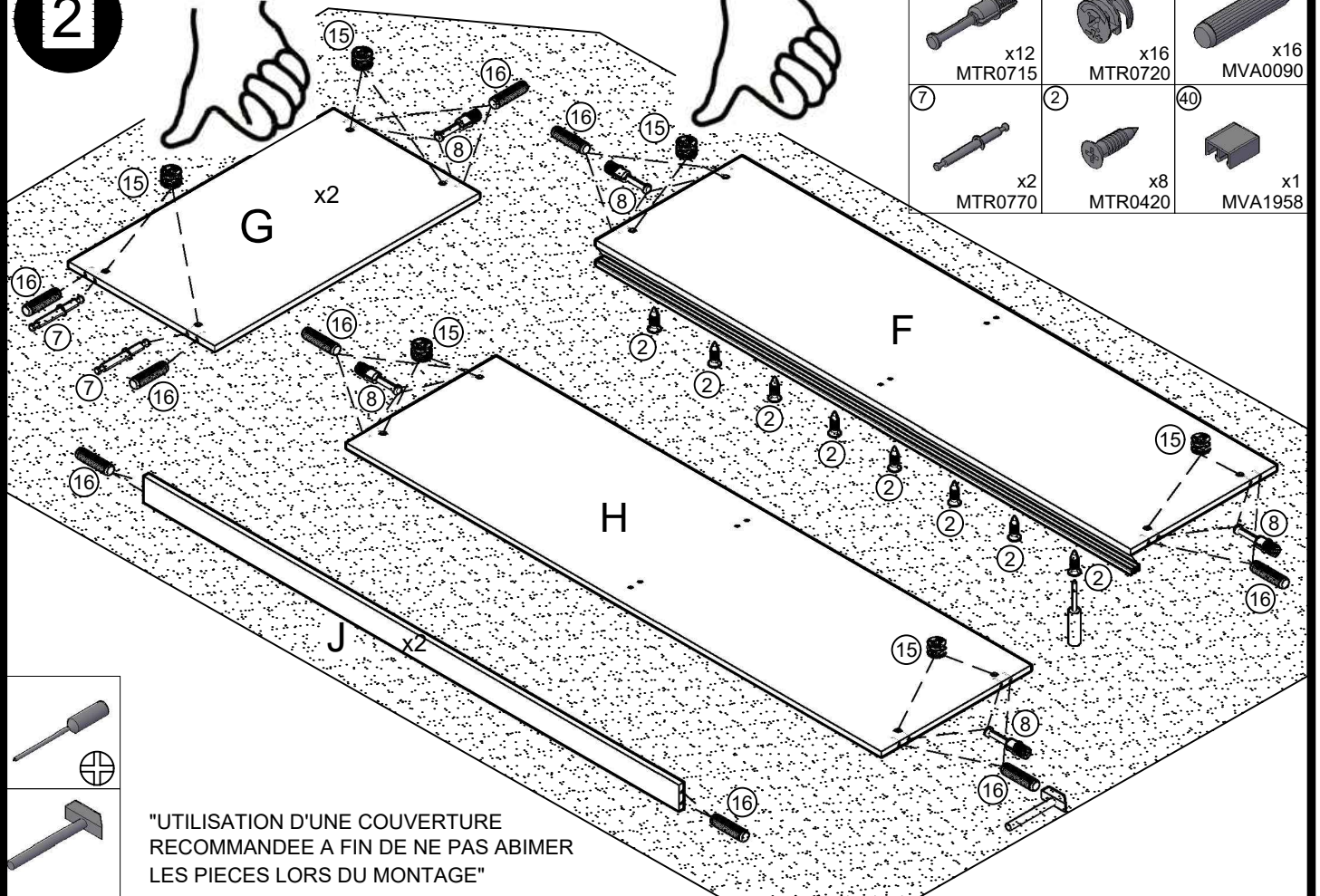

"UTILISATION D'UNE COUVERTURE RECOMMANDÉE A FIN DE NE PAS ABIMER LES PIÈCES LORS DU MONTAGE"

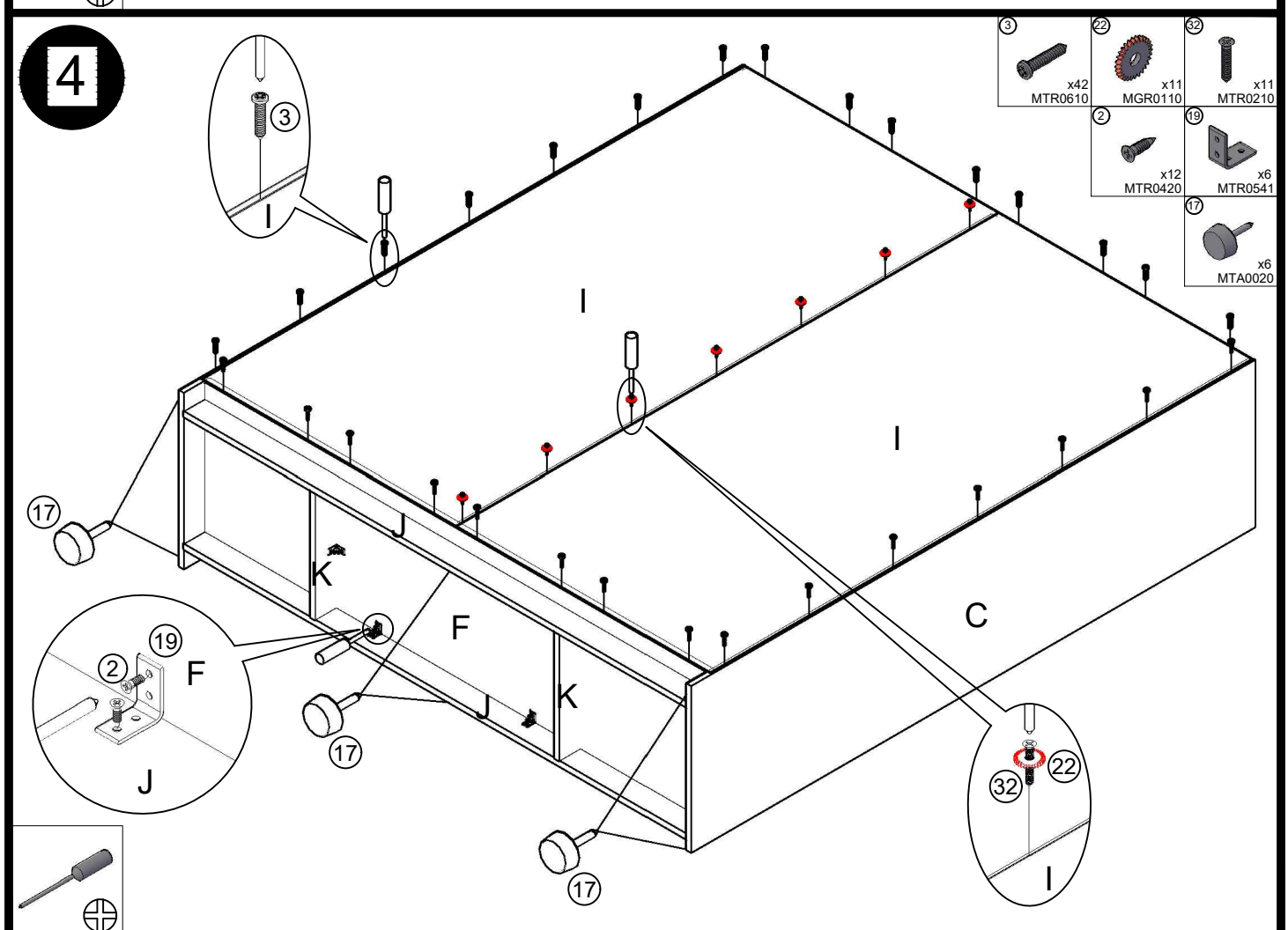
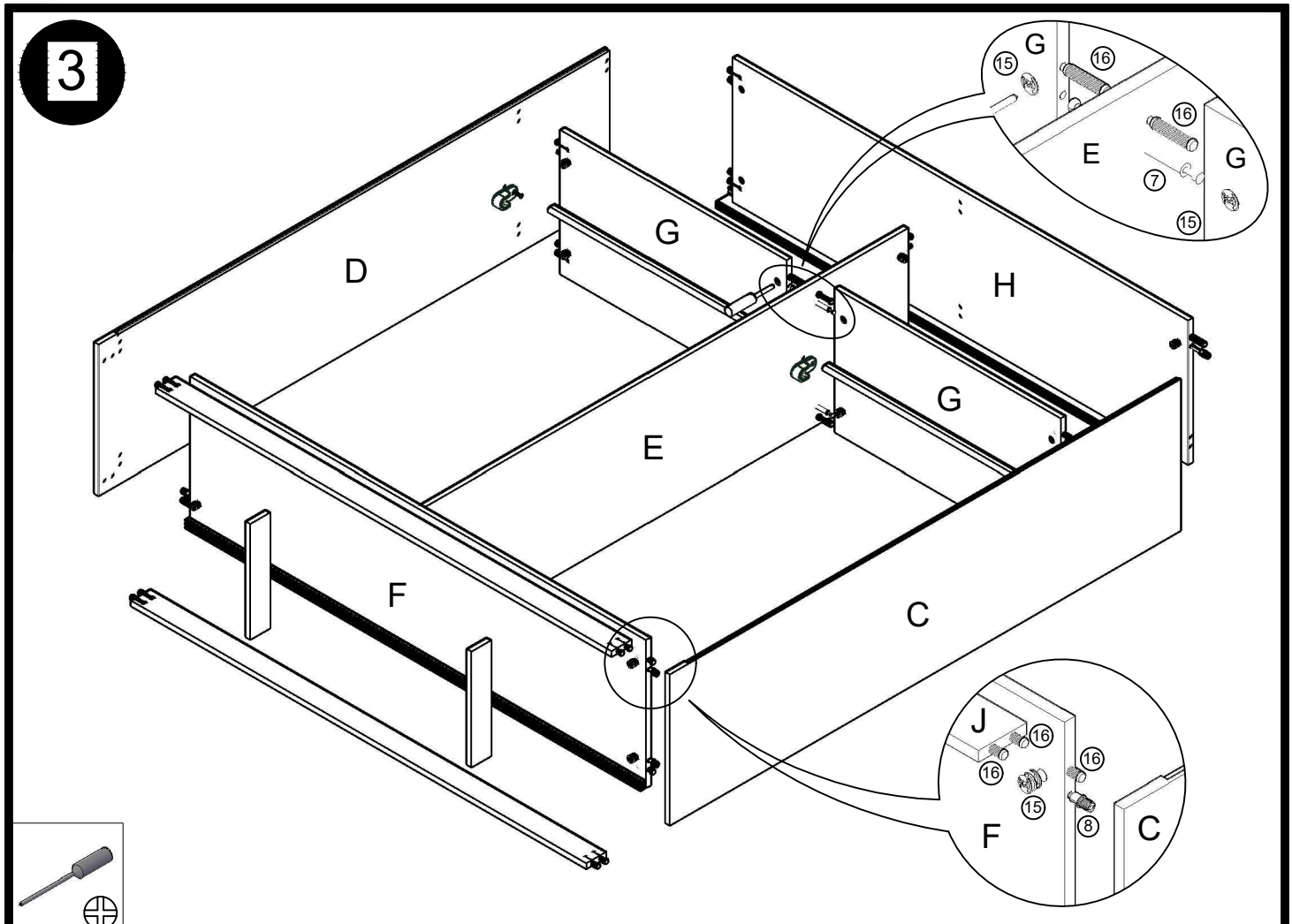

5

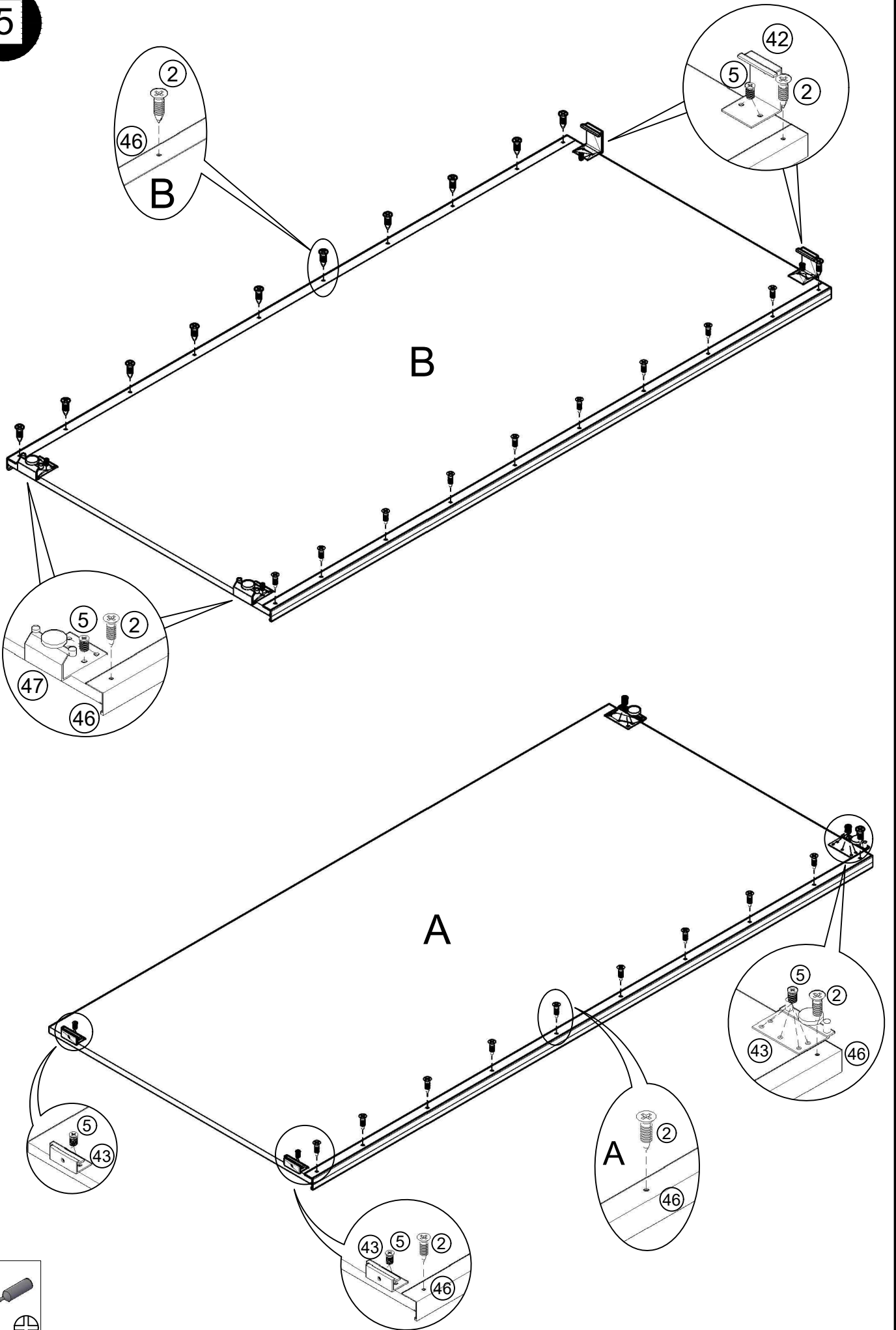

6

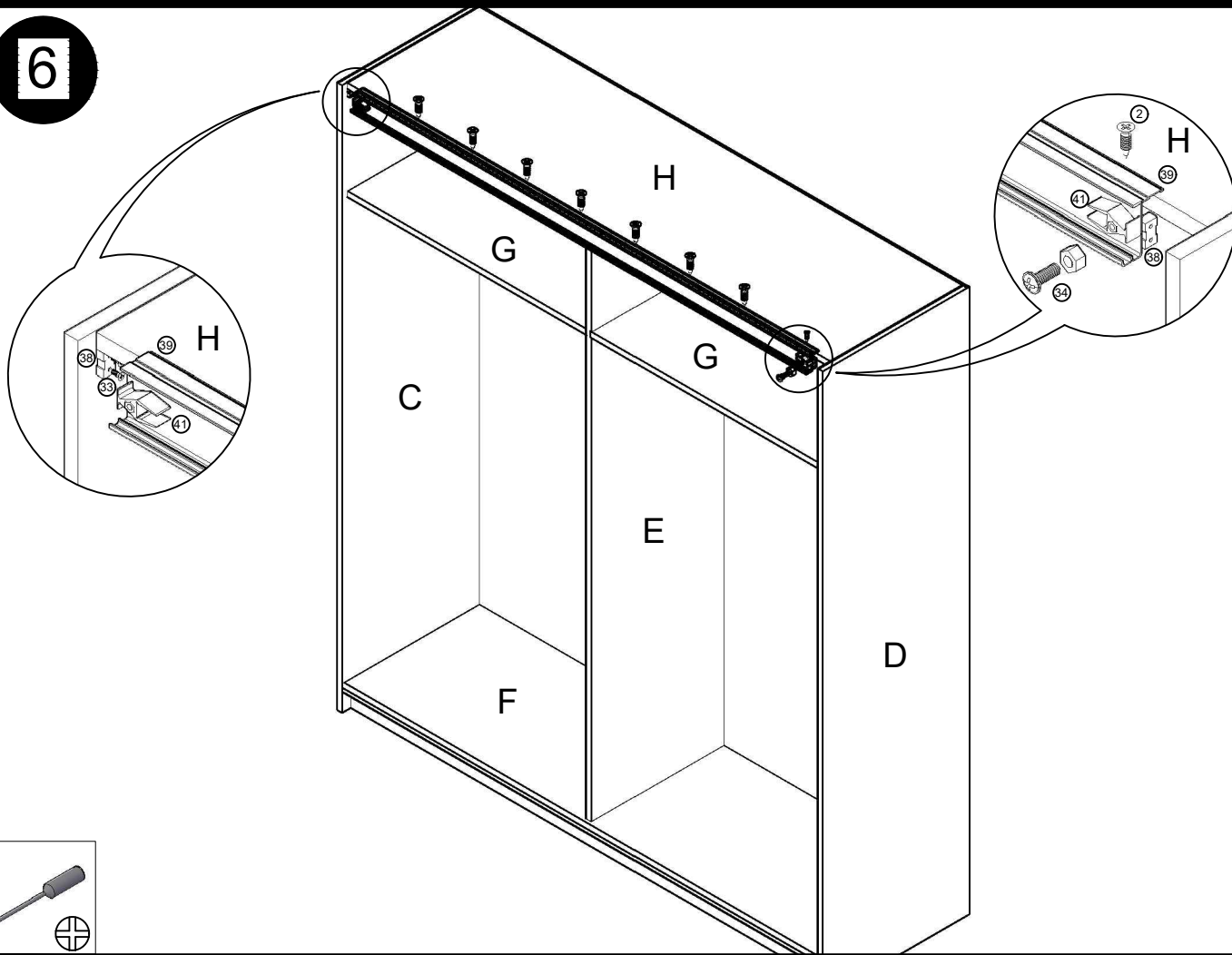

7

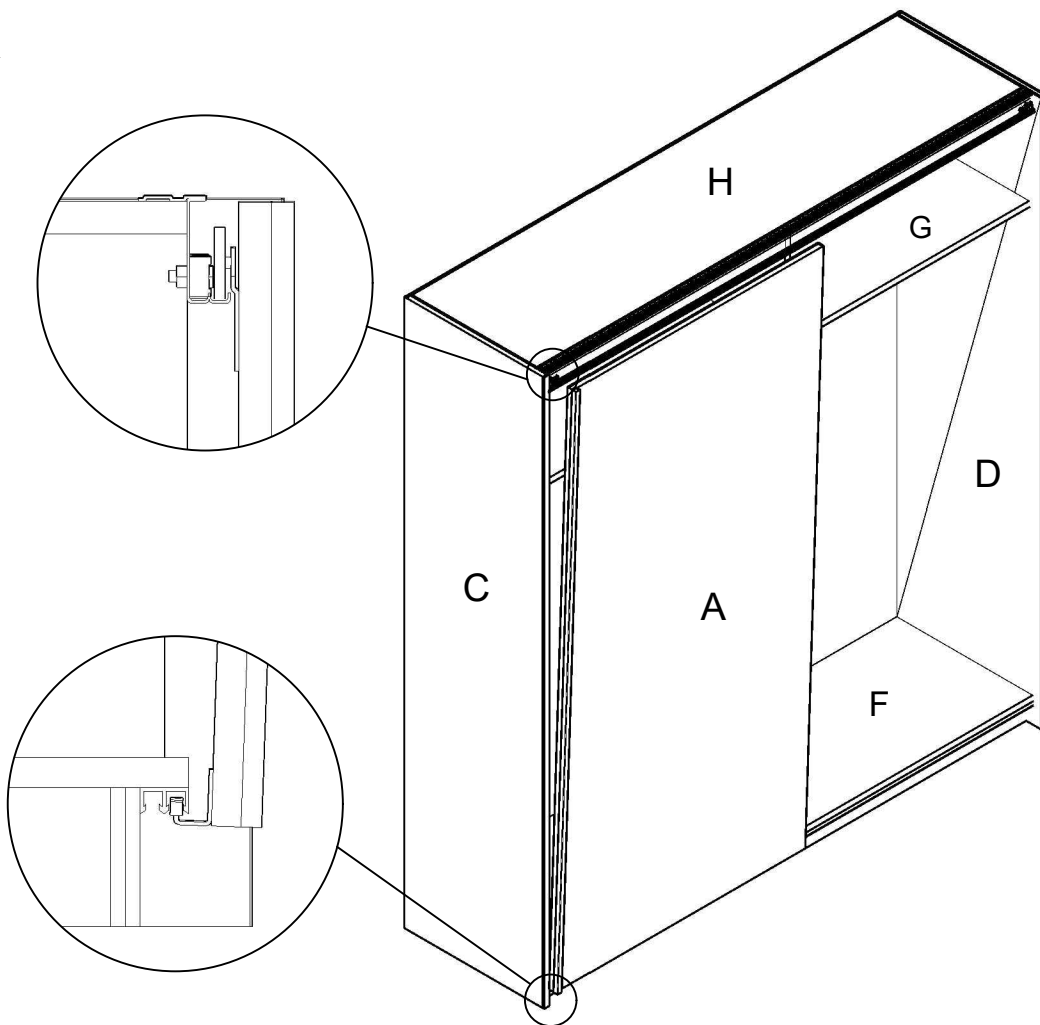

8

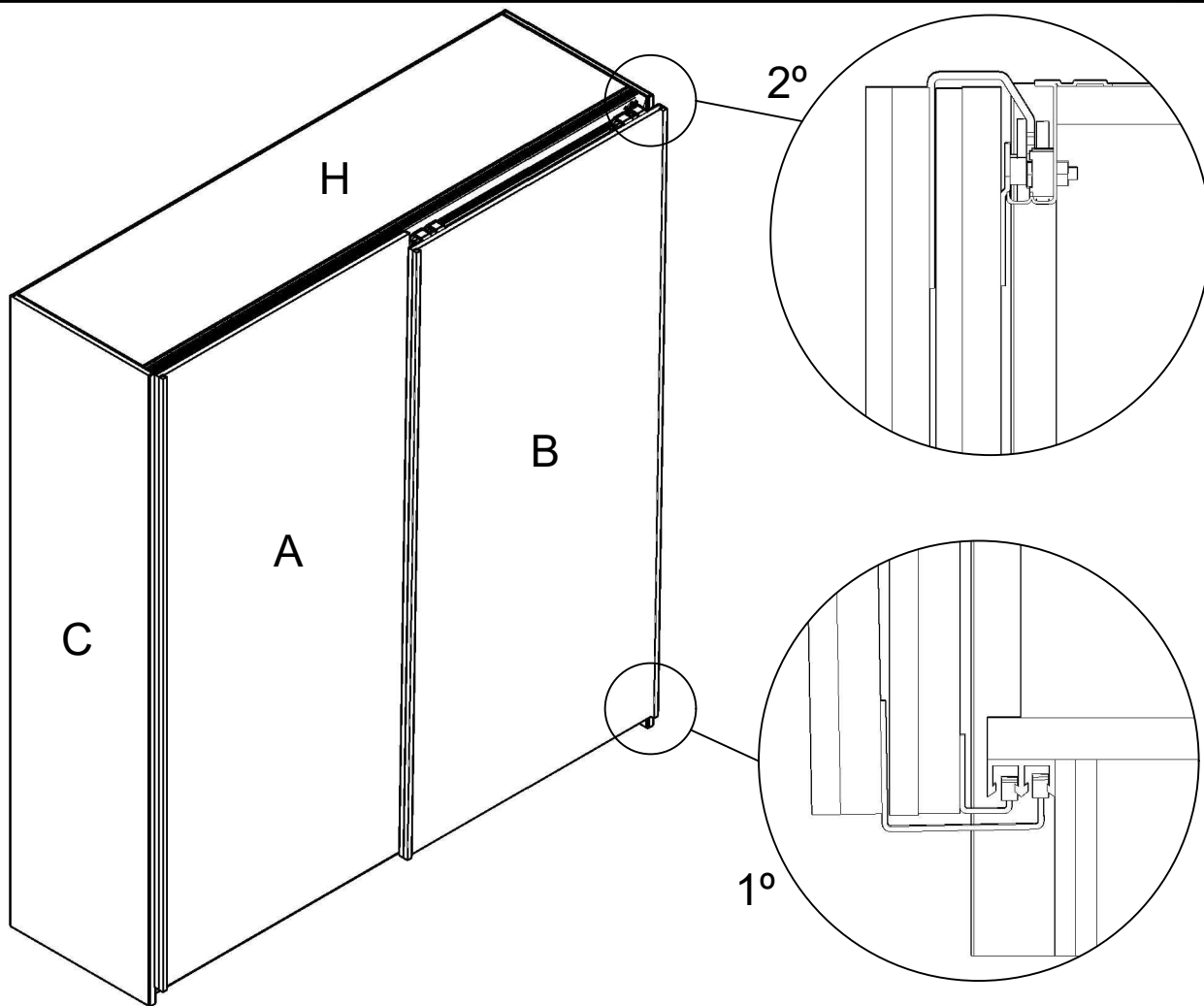

9

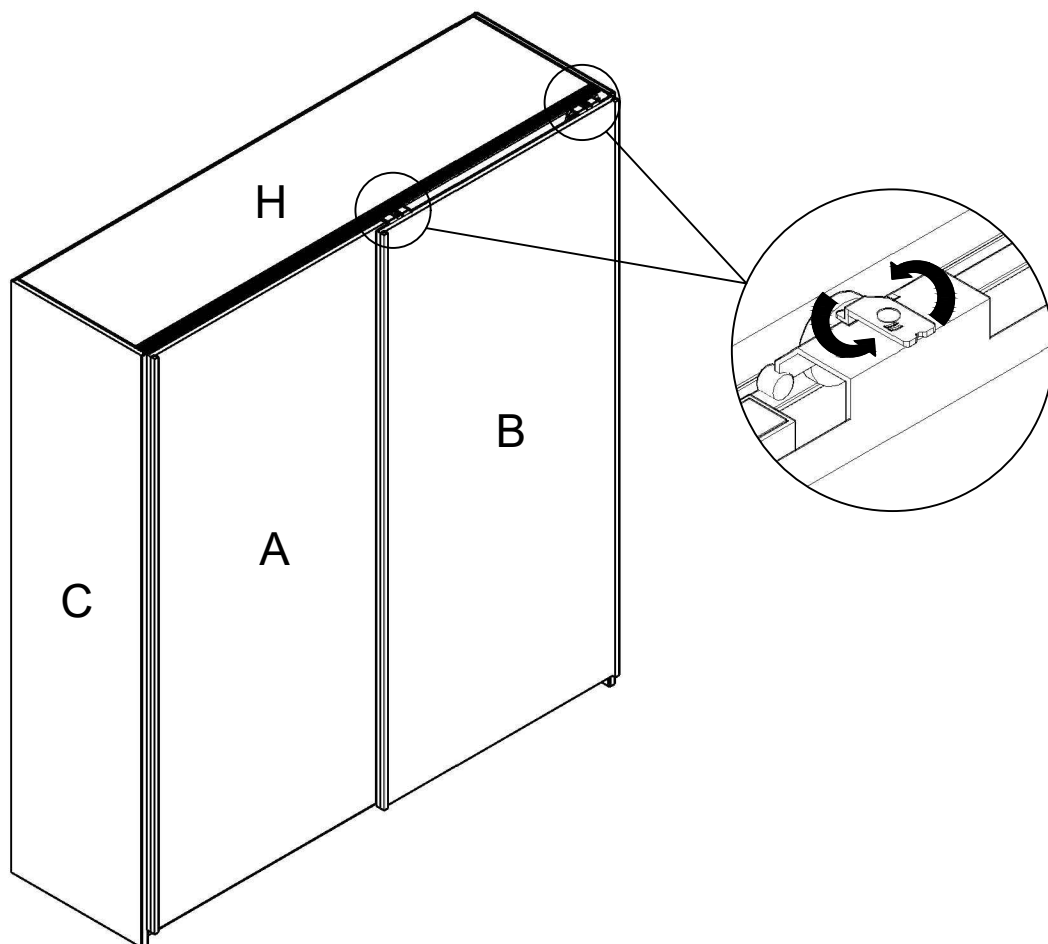

FRANÇÉS: "Après assemblage de ce produit, il est conseillé d'aérer régulièrement la pièce pendant quelques jours".

INGLÉS: "After assembling this product, it is recommended to regularly ventilate the room for a few days".

ESPAÑOL: "Después de montar este producto, es aconsejable ventilar la habitación frecuentemente, durante unos días".

FRANCAIS - SUISSE

CONSEILS DE MONTAGE :

- 1 > BIEN ETUDIER LA NOTICE DE MONTAGE.
- 2 > REPEREZ LES PIECES CONSTITUANT VOTRE MEUBLE.
- 3 > REGROUPEZ ET CONTROLEZ LA QUINCAILLERIE.
- 4 > MUNISSEZ-VOUS DE L'OUTILLAGE NECESSAIRE.
- 5 > AMENAGEZ-VOUS UNE ZONE DE MONTAGE.
- 6 > PROCEDEZ AU MONTAGE.



**NE JAMAIS FORCER LES ASSEMBLAGES.
RESSERREZ LES VIS APRES QUELQUES TEMPS D'USAGE.
GARDER VOTRE NOTICE DE MONTAGE, SI UNE PIECE
VENAIT A MANQUER, ELLE SERAIT LE PLUS CLAIR
MOYEN DE COMMUNIQUER AVEC VOTRE MAGASIN.**

CONSEILS D'ENTRETIEN :

- 1 > DÉPOUSSIÉREZ SOIGNEUSEMENT.
- 2 > UTILISEZ UN CHIFFON SEC.



**- NE JAMAIS UTILISER
DE PRODUITS ABRASIFS:
POUDRE, LAINE D'ACIER, SOLVANTS.
- NE PAS MOUILLER**

| | PAPIER DECOR | SURFACES STRATIFIÉES | SURFACES LAQUÉES | BOIS VERNIS | TEXTILE CUIR |
|--------------------------------|-----------------|-------------------------|---------------------|----------------|-----------------|
| EAU SAVONNEUSE (SAVON NEUTRE) | ○ | ○ | ○ | ○ | ○ |
| EAU ADDITIO NÉE | | ○ | ○ | | |
| ENTRETIEN SPÉCIFIQUE FABRICANT | | | | | ○ |

DEUTSCH - SCHWEIZ

MONTAGE ANLEITUNG:

- 1 > DIE MONTAGEANLEITUNG SORGFÄLTIG DURCHLESEN.
- 2 > DIE EINZELTEILE DES MÖBELSTÜCKS ERMITTELN.
- 3 > DIE BESCHLÄGE ZUSAMMENLEGEN UND PRÜFEN.
- 4 > DAS NOTWENDIGE WERKZEUG ZURECHTLEGEN.
- 5 > EINEN MONTAGEBEREICH FREIMACHEN.
- 6 > DAS MÖBELSTÜCK ZUSAMMENBAUEN.



**NIEMALS DIE VERBINDUNGEN ZU STARK ANZIEHEN.
DIE SCHRAUBEN NACH EINIGER ZEIT DES GEBRAUCHS
ERNEUT FESTZIEHEN. DIE MONTAGEANLEITUNG
GUT AUFBEWAHREN: SOLLTE EIN TEIL FEHLEN, IST SIE DAS
BESTE VERSTÄNDIGUNGSMITTEL MIT IHREM GESCHÄFT.**

PFLEGEHINWEISE :

- 1 > SORGFÄLTIG ENTSTAUBEN.
- 2 > VERWENDEN SIE EIN TROCKENES TUCH.



**- BENUTZEN SIE KEINE
SCHEUERMITTEL WIE PULVER,
STAHLWOLLE, LÖSUNGSMITTEL.
- KEIN WASSER VERWENDEN.**

| | DEKORPAPIER | OBERFLÄCHE LAMINAT | OBERFLÄCHE LACK | LACKIERTEM HOLZ | TEXUL LEDER |
|----------------------------------|-------------|-----------------------|--------------------|--------------------|----------------|
| SEIFENLAUGE (NEUTRALSEIFE) | ○ | ○ | ○ | ○ | ○ |
| WASSER MIT HAUSHALTSRFINGER | | ○ | ○ | | |
| PRODUZENT SPEZIFISCHER UNTERHALT | | | | | ○ |

ITALIANO - SVIZZERA

CONSIGLI DI MONTAGGIO

- 1 > STUDIARE BENE LE ISTRUZIONI DI MONTAGGIO.
- 2 > PRENDERE CONOSCENZA DEI PEZZI CHE COSTITUISCONO IL MOBILE.
- 3 > RAGGRUPPARE E CONTROLLARE LA FERRAMENTA.
- 4 > MUNIRSI DEGLI UTENSILI NECESSARI.
- 5 > PREPARARE UNA ZONA DI MONTAGGIO.
- 6 > PROCEDERE AL MONTAGGIO.



**NON FORZARE MAI GLI ASSEMBLAGGI
RISTRINGERE LE VITI DOPO UN PERIODO D'USO
CONSERVARE QUESTE ISTRUZIONI DI MONTAGGIO,
SE UN PEZZO VENISSE A MANCARE SAREBBE IL MIGLIORE
MEZZO DI COMUNICAZIONE CON IL RIVENDITORE**

CONSIGLI PER LA MANUTENZIONE :

- 1 > SPOLVERATE ACCURATAMENLE.
- 2 > USARE UN PANNINO ASCIUTTO.



**- NON UTILIZZARE MAI PRODOTTI
ABRASIVI: POLVERE,
LANA DI ACCIAIO, SOLVENTI.
- NON BAGNARE.**

| | CARTA | SUPERFICIE STRATIFICATE | SUPERFICIE LACCATE | LACCATE EGNO VERNICIATO | TESSILE CUOIO |
|-----------------------------------|-------|----------------------------|-----------------------|----------------------------|------------------|
| ACQUA CON SAPONE (SAPONE NEUTRO) | ○ | ○ | ○ | ○ | ○ |
| ACQUA CON DETERSIVO SAN MARC | | ○ | ○ | | |
| MANUTENZIONE SPECIFICA PRODUTTORE | | | | | ○ |

PORTUGUÊS

CONSELHOS DE MONTAGEM:

- 1 > ESTUDE BEM AS INSTRUÇÕES DE MONTAGEM.
- 2 > REUNA AS PEÇAS QUE CONSTITUEM O SEU MÓVEL.
- 3 > REAGRUPE AS FERRAGENS.
- 4 > EQUIPE-SE COM AS FERRAMENTAS NECESSÁRIAS.
- 5 > PREPARE UMA ÁREA PARA A MONTAGEM.
- 6 > INICIE A MONTAGEM.



**NUNCA FORÇAR OS ENCAIXES.
REAPERTAR OS PARAFUSOS APÓS UM TEMPO DE UTILIZAÇÃO.
GUARDAR AS INSTRUÇÕES DE MONTAGEM.
CASO FALTE ALGUMA PEÇA, O MAIS ACONSELHÁVEL
É CONTATAR O REVENDEDOR.**

CONSELHOS PARA A MANUTENÇÃO :

- 1 > ELIMINAR BEM O PÓ.
- 2 > USAR PANO SECO.



**- NUNCA UTILIZAR PRODUTOS
ABRASIVOS: SAPONÁCEOS,
LÃ DE AÇO, SOLVENTES.
- NÃO MOLHAR .**

| | ACABAMENTO IMITAÇÃO | SUPERFÍCIES ESTRATIFICADAS | SUPERFÍCIES LACADAS | MADEIRA ENVERNIZADA | TEXTEIS PELES |
|--------------------------------------|------------------------|-------------------------------|------------------------|------------------------|------------------|
| ÁGUA COM SABÃO (SABÃO NEUTRO) | ○ | ○ | ○ | ○ | ○ |
| ÁGUA COM DETERGENTE | | ○ | ○ | | |
| INSTRUÇÕES ESPECÍFICAS DO FABRICANTE | | | | | ○ |

ESPAÑOL

CONSEJOS PARA EL MONTAJE:

- 1 > ESTUDIE ATENTAMENTE EL MANUAL DE MONTAJE.
- 2 > LOCALICE LAS PIEZAS QUE CONSTITUYEN SU MUEBLE.
- 3 > REUNA Y CONTROLE LOS TORNILLOS.
- 4 > EQUIPE-SE DE LAS HERRAMIENTAS NECESARIAS.
- 5 > PREPARE UNA ZONA DE MONTAJE.
- 6 > REALICE EL MONTAJE.



**NO FUERCE NUNCA EN LAS UNIONES. APRIETE LOS
TORNILLOS DESPUES DE CIERTO TIEMPO DE UTILIZACION
CONSERVE SU MANUAL DE MONTAJE,
SI FALTARA UNA PIEZA, SERIA LA MANERA
MAS FACIL DE COMUNICAR CON LA TIENDA.**

CONSEJOS PARA EL MANTENIMIENTO:

- 1 > DESPOLVOREAR CULDADOSAMENTE.
- 2 > UTILICE UN PAÑO SECO.



**- NO USE NUNCA PRODUCTOS
ABRASIVOS TALES COMO:
POLVO DE LIMPIAR,
LANA DE ACERO, SOLVENTES.
- NO MOJAR.**

| | PAPEL DE DECORACION | SUPERFICIE ESTRATIFICADAS | SUPERFICIE MAQUEADAS | MADERA BARNIZADA | TEXULL CUERO |
|---|------------------------|------------------------------|-------------------------|---------------------|-----------------|
| AGUA Y JABON (JABON NEUTRO) | ○ | ○ | ○ | ○ | ○ |
| AGUA COM DETERGENTE | | ○ | ○ | | |
| MANTENIMIENTO ESPECIFICO DEL FABRICANTE | | | | | ○ |

HRVATSKA

UPUTE ZA MONTAŽU:

- 1 > PAŽLJIVO PROČITAJTE UPUTE ZA MONTAŽU.
- 2 > PRIPREMITE SVE DIJELOVE NAMJEŠTAJA.
- 3 > PRIKUPITE I PROVJERITE OKOVE ZA MONTAŽU.
- 4 > PRIPREMITE POTREBAN ALAT.
- 5 > PRIPREMITE PROSTOR ZA MONTAŽU.
- 6 > POČNITE MONTIRATI.



**NEMOJTE UPOTREBLJAVATI SILU PRILIKOM SKLAPANJA
NAKON NEKOG VREMENA PONOVRNO PRITEGNITE VIJKE
ČUVAJTE UPUTE ZA MONTAŽU
U SLUČAJU NEDOSTATKA NEKOG DIJELA NAJBOLJE ĆE BITI DA
DA KONTAKIRATE PRODAJNO MJESTO.**

UPUTE ZA ODRŽAVANJE :

- 1 > PAŽLJIVO OBRISATI PRAŠINU.
- 2 > KORISTITE SUHU KRPU.



**- ZABRANJENA JE UPOTREBA
KEMIKALIJA ILI BILO KAKVIH
POMOĆNIH SREDSTAVA ZA RIBANJE
JAKIH SREDSTAV ZA ČIŠĆENJE ILI
ČELIČNE VUNE
-NE MOKRA.**

| | PAPIR | LAMINAT | LAK | DRVO | TEKSTIL/ KOŽA |
|--------------------|-------|---------|-----|------|------------------|
| OTPINA SAPUNA | ○ | ○ | ○ | ○ | ○ |
| OTPINA DETERDŽENTA | | ○ | ○ | | |
| NAMJENSKA SREDSTVA | | | | | ○ |

TÜRÇE

MONTAJ TALIMATLARI:

- 1 > MONTAJ TANITIM YAZISINI DIKKATLICE OKUYUNUZ.
- 2 > MOBİLYANIZI OLUŞTURAN PARÇALARI İŞARETLEYİNİZ.
- 3 > HIRDAVATLA İLGİLİ PARÇALARI BİR ARAYA TOPLAYIP; KONTROL EDİNİZ.
- 4 > GEREKEN ARAÇ VE GERECEİ TEDARİK EDİNİZ.
- 5 > (KENDİNİZE) BİR MONTAJ ALANI EDİNİNİZ.
- 6 > MONTE ETMEYE BAŞLAYINIZ.

MONTAJLARI ZORLAMAYINIZ.
BİRKAÇ KULLANIMDAN SONRA VIDALARI SIKIŞTIRINIZ.
BİR PARÇANIN KAYBOLMASI DURUMUNDA MAGAZANIZLADAKİ KOLAY İLETİŞİME GEÇEBİLMENİZ İÇİN MONTAJ KULLANIM TALİMATINIZI SAKLAYINIZ.

BAKIM TALIMATLARI:

- 1 > TOZUNU DIKKATLICE ALINIZ.
- 2 > YUMUŞAK BİR BEZİ TEMİZ SU VE AZ MIKTARDA SABUNLA(DETERJAN) NEMLENDİRİNİZ.

ASLA AŞINDIRICI ÜRÜNLER KULLANMAYINIZ : ÇELİK YÜNÜ, SOLVENT... BOL SUYLA YIKAMAYINIZ.

| | SÜS KAGIDI | KATMAN YÜZEY | LAKE YÜZEY | CILALI TAHTA | TEKSTİL DERİ |
|-------------------------|------------|--------------|------------|--------------|--------------|
| SABUNLU SU (NOTR SABUN) | ○ | ○ | ○ | ○ | ○ |
| DETERJAN KATILMIŞ SU | | ○ | ○ | | |
| ÜRETİCİYE ÖZGÜ BAKIM | | | | | ○ |

ENGLISH

ASSEMBLY ADVICE :

- 1 > CAREFULLY READ THE ASSEMBLY INSTRUCTION.
- 2 > IDENTIFY THE COMPONENTS OF THE FURNITURE.
- 3 > GROUP AND CHECK THE HARDWARE.
- 4 > USE THE REQUIRED TOOLS.
- 5 > CREATE AN ASSEMBLY ZONE.
- 6 > MAKE THE ASSEMBLY.

NEVER FORCE THE CONNECTIONS.
RE-TIGHTEN THE SCREWS AFTER FEW DAYS.
PLEASE RETAIN THE AI LEAFLET FOR FUTURE REFERENCE, THE AI CONTAINS INFORMATION WHEN CLAIMING FOR MISSING PARTS.

CLEANING ADVICE:

- 1 > CAREFULLY REMOVE THE DUST.
- 2 > USE A SOFT, CLEAN DAMP CLOTH WITH SOAPY WATER.

NEVER USE ABRASIVE PRODUCTS OR SOLVENTS.
DO NOT APPLY EXCESSIVE PRESSURE WHEN USING THE DAMP CLOTH.

| | PAPER DECOR | LAMINATED SURFACES | LACQUERED SURFACE | VARNISHED WOOD | LEATHER TEXTILE |
|----------------------------|-------------|--------------------|-------------------|----------------|-----------------|
| SOAPY WATER (NEUTRAL SOAP) | ○ | ○ | ○ | ○ | ○ |
| WATER WITH DETERGENT | | ○ | ○ | | |
| SPECIFIC SUPPLIER CLEANING | | | | | ○ |



FR

Donnez ou recyclez vos meubles.



Association

OU



Magasin

OU



Déchèterie



LE TRI FACILE

