

THIS INSTRUCTION BOOKLET CONTAINS
IMPORTANT SAFETY INFORMATION. PLEASE
READ AND KEEP FOR FUTURE REFERENCE.



DO NOT RETURN PRODUCT TO THE STORE
Individual stores do not stock parts.

Lot Number: _____

Date Of Purchase: ____/____/____

If a part is missing or damaged, call our toll-free customer service line.
We will gladly ship your replacement parts FREE of charge.

Need Parts or Assistance?

1-800-489-3351
or access our website
www.ameriwood.com/parts

For prompt, reliable service please have your assembly manual ready.

Recommended # of people needed for assembly:2
(However it is always better to have an extra hand.)

Spanish translations are located in the center of this manual.

Thank you for purchasing from AMERIWOOD.

Visit www.ameriwood.com to view the limited warranty valid in the U.S. and Canada.

BEFORE STARTING

- Read each step carefully before starting. It is very important that each step of instruction is performed in the correct order. If these steps are not followed in sequence, assembly difficulties will occur.
- Make sure all parts are included. Most board parts are labeled or stamped on the raw edge.
- Work in spacious area, preferably on a carpet, near the place the unit will be used.
- Have the following tools close at hand.
- Do not use power tools to assemble your furniture. Power tools may strip or damage the parts.

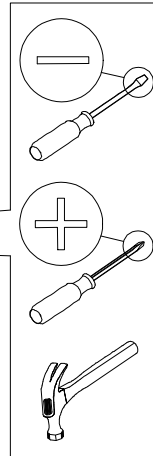

HELPFUL HINTS

- Visit our website for assembly video clips.
- Call our toll free number if you need assistance.
- Compression dowels are tapped in with a hammer.
- Back panels provide stability and support. Use all the nails provided. Units without the back panel installed may collapse.
- When tapping nails into a board, be sure there are equal margins on all side to square the unit.
- Move your new furniture carefully, with two people lift and carry the unit to it's new location.
- Never push, drag or scoot your furniture (especially on carpet).
- Your ALTRAFURNITURE can be disassembled and reassembled to move.
- Additional parts are available for a nominal fee.

For help with assembly, identifying parts, product information or to order parts, please contact us:



Call us at: 1-800-489-3351

Monday-Friday

9:00 am - 5:00 pm

(Central Time)



FAX:

1-636-745-1005

available 24 hours a day,
7 days a week

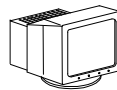

Visit our website:

www.ameriwood.com/parts



Write to:

AMERIWOOD INDUSTRIES
410 East 1st Street South
Wright City, MO 63390 USA
Attn: Service Dept.

PARTS

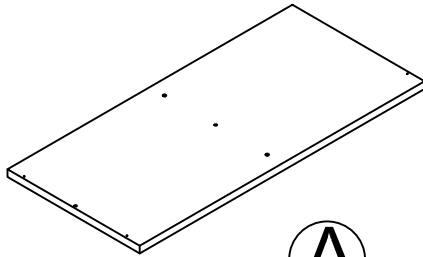

A

TOP
T1748396010

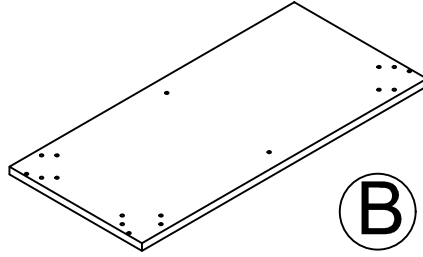

B

BOTTOM
T1748396020

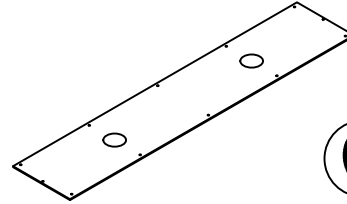

C

BACK PANEL
T1748396030

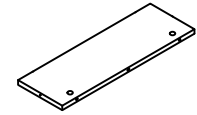

D

LEFT SIDE PANEL
T1748396040

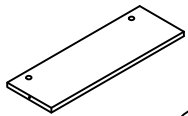

E

RIGHT SIDE PANEL
T1748396050

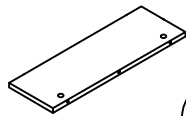

F

PARTITION
T1748396060



G

LEG
T1748396070
QTY:4

PARTS

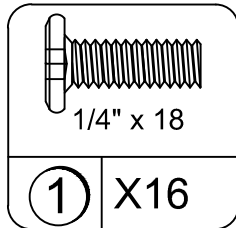

1/4" x 18

① X16

BOLT
TTL2060
Spare: 2

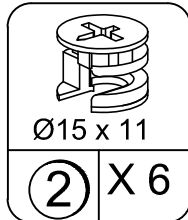

Ø15 x 11

② X 6

CAM LOCK
TTL6025
Spare:1

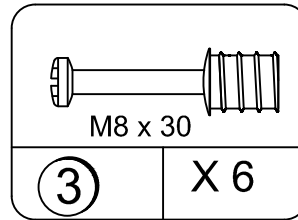

M8 x 30

③ X 6

CAM BOLT
TTL6026
Spare:1

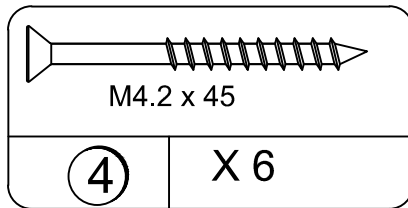

M4.2 x 45

④ X 6

SCREW
TTL1079
Spare:1

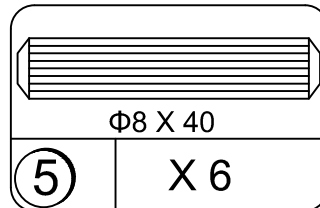

Ø8 X 40

⑤ X 6

WOOD DOWEL
TTL4005
Spare:1

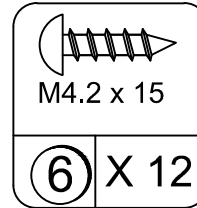

M4.2 x 15

⑥ X 12

SCREW
TTL1009
Spare:2

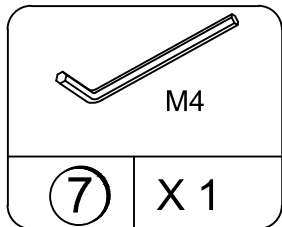

M4

⑦ X 1

HEX KEY
TTL5015



**WARNING
ADVERTENCIA**

WARNING LABEL
TTL1748

This illustration shows how the CAM fastening system works.

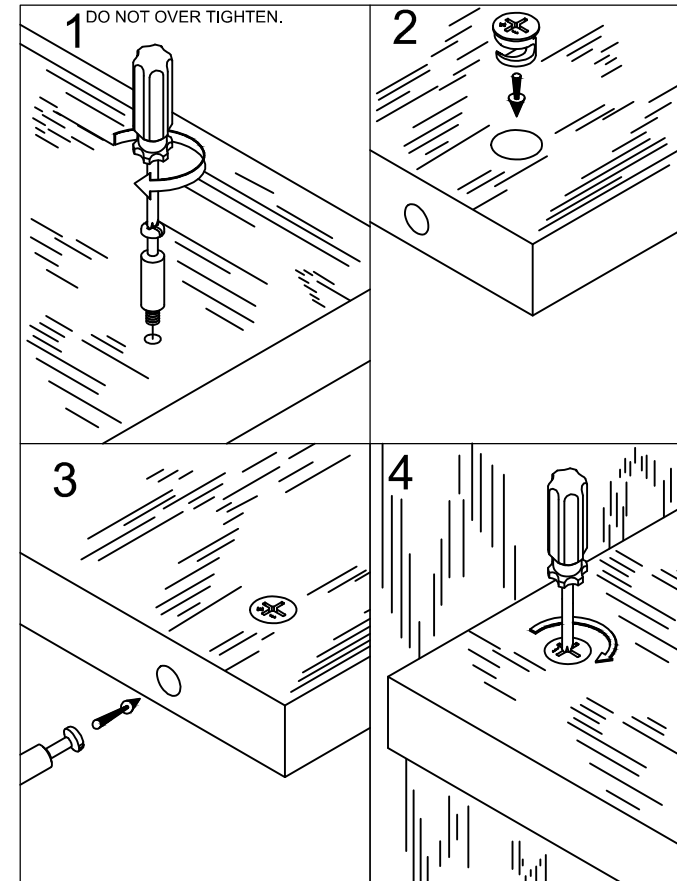

To view a video on how the CAM fastening system works, download a free QR-reader on your smartphone, then scan the code.

1

- Screw six cam bolts (3) into the holes of top (A) as below shown.
- Insert three wood dowel (5) into the holes of top (A) as below shown.

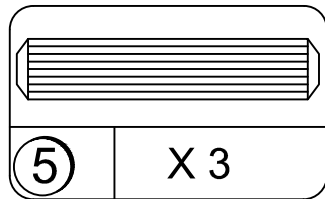
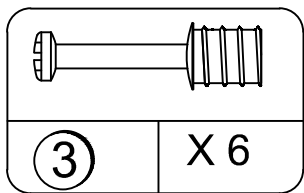
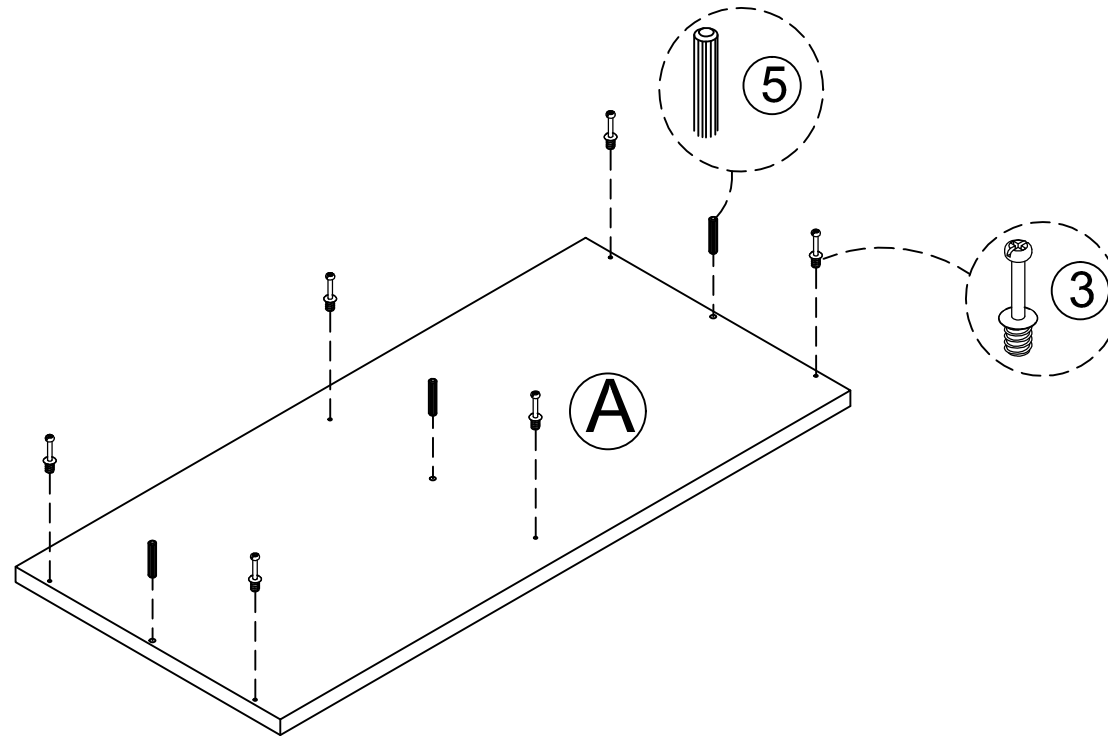

2

- Attach panels (D&E&F) to top (A) with six cam locks (2) as below shown.
- Insert three wood dowel (5) into the holes of panels (D&E&F) as below shown.

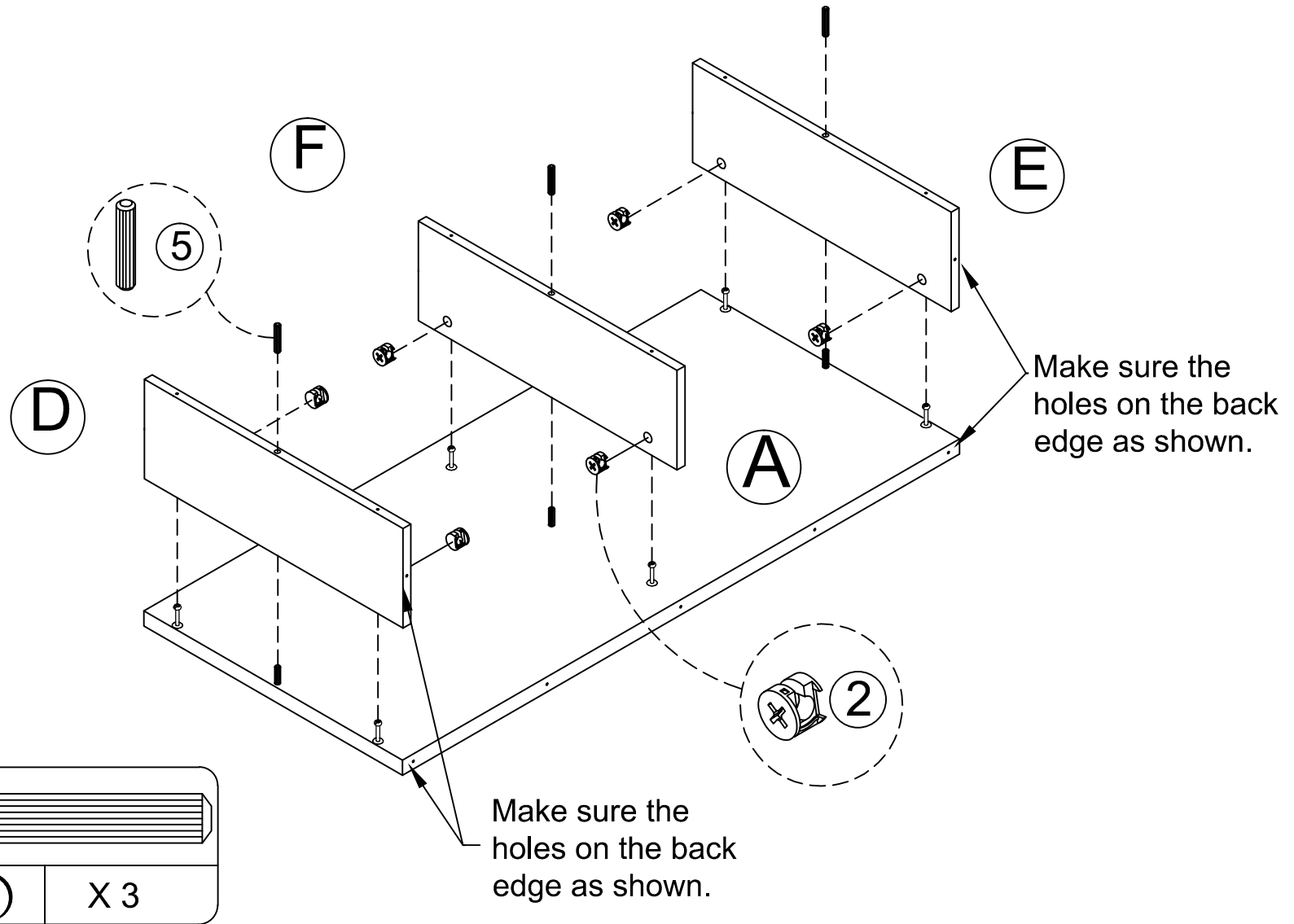

3

- Attach bottom (B) to assembled unit with six screws (4) as below shown.

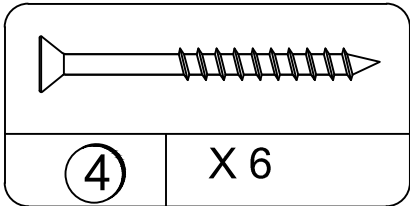
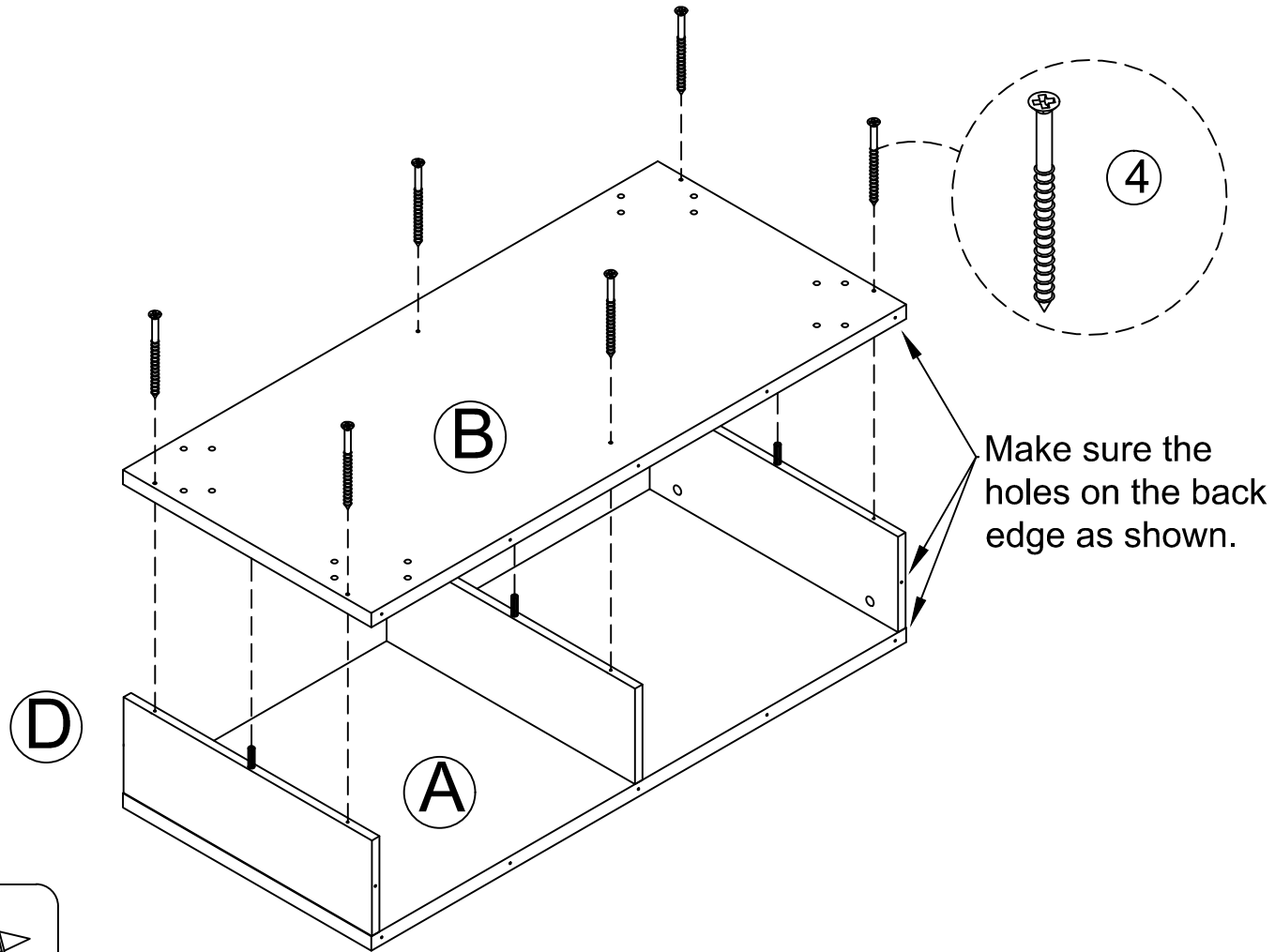

4

- Attach back panel (C) to assembled unit with twelve screws (6) as below shown.

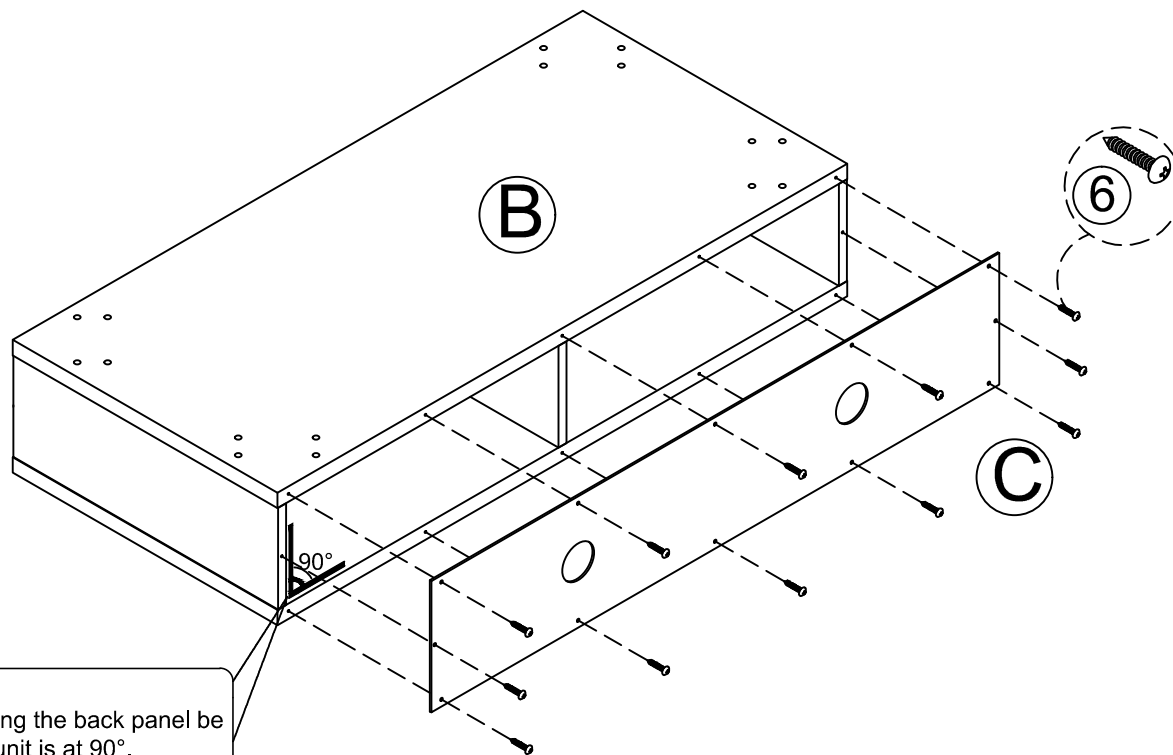

Before attaching the back panel be sure that the unit is at 90°.

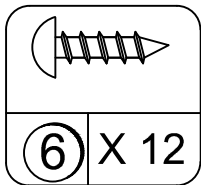

5 - Attach four legs (G) to assembled unit with sixteen bolts (1) as below shown.

