

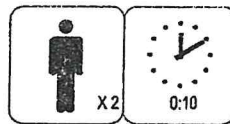

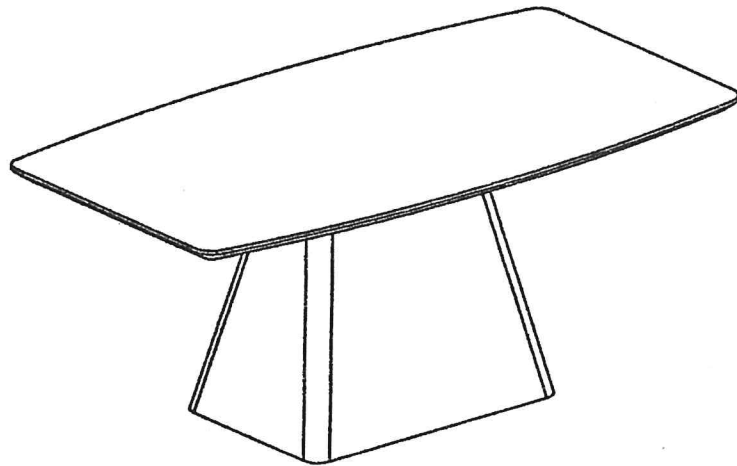



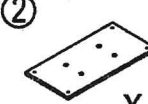

# ASSEMBLY INSTRUCTIONS

DINING TABLE MODEL#: ADTL2204



 <p>① X 1</p>	 <p>② X 1</p>	 <p>③ X 1</p>			
 <p>A M8*35 X 4</p>	 <p>B M8*45 X 4</p>	 <p>C X 8</p>	 <p>D X 1</p>	 <p>E X 8</p>	

