

# NOTICE DE MONTAGE

## INSTRUCCIONES DE MONTAJE / ASSEMBLY INSTRUCTIONS

**ME**  
marckeric

MARCKERIC S.L.  
C/ENLACE VEROLA S/N  
PC:46430/SOLLANA/VALENCIA/SPAIN

ESTANTERIA AVIVA  
BOOKSHELF AVIVA  
ETAGERE AVIVA

16170

EAN CODE:  
8435178397911

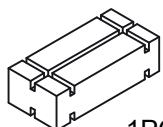

1PC / 2CTNS

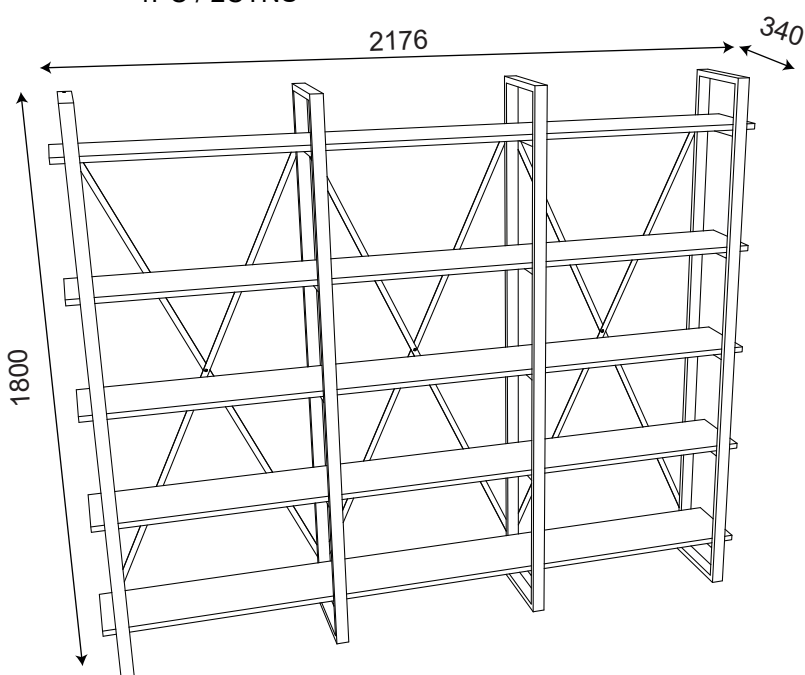

"NE PAS UTILISER SI UNE PARTIE EST CASSÉE,  
ENDOMMAGÉE OU MANQUANTE"

"IMPORTANT - À CONSERVER POUR RÉFÉRENCE  
ULTÉRIEURE - LIRE ATTENTIVEMENT"

À MONTER SOI-MÊME

Tamaño de la cajas Dimensions colis Carton dimensions	Peso bruto Poids brut Gross weight	Peso neto Poids net Net weight
1870 x 395 x 180 mm	23.76 kg	22.00 kg
2230 x 350 x 95 mm	38.90 kg	37.50 kg

AVANT DE COMMENCER, SE  
REPORTER AUX CONSEILS  
DE MONTAGE EN ANNEXE

**BEFORE STARTING, REFER  
TO THE ASSEMBLING ADVICE  
IN ANNEX**

VOR DER MONTAGE,  
BEILIGE ANWEISUNGEN  
BEFOLGEN.

**PRIMA DI COMINCIARE  
LEGGETE LE ISTRUZIONI  
DI MONTAGGIO**

ANTES DE COMEÇAR, DAR  
SE AOS CONSELHOS DE  
MONTAGEM EM ANEXO

**ANTES DE EMPEZAR  
CONSULTE LOS CONSEJOS  
PARA EL MONTAJE**

PRIJE POČETKA POGLEDAJTE  
ZA SAVJET ZA MONTAŽU  
U ANEKSU

**BAŞLAMADAN ÖNCE,  
EKTEKİ MONTAJ  
TALİMATLARINI İNCELEYİNİZ**

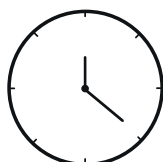
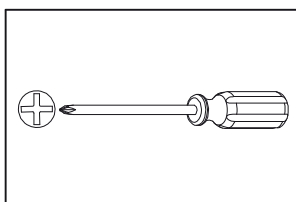
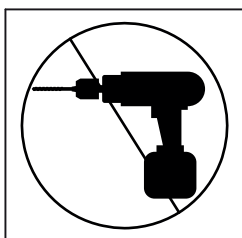

60MN

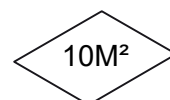
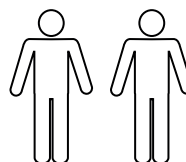

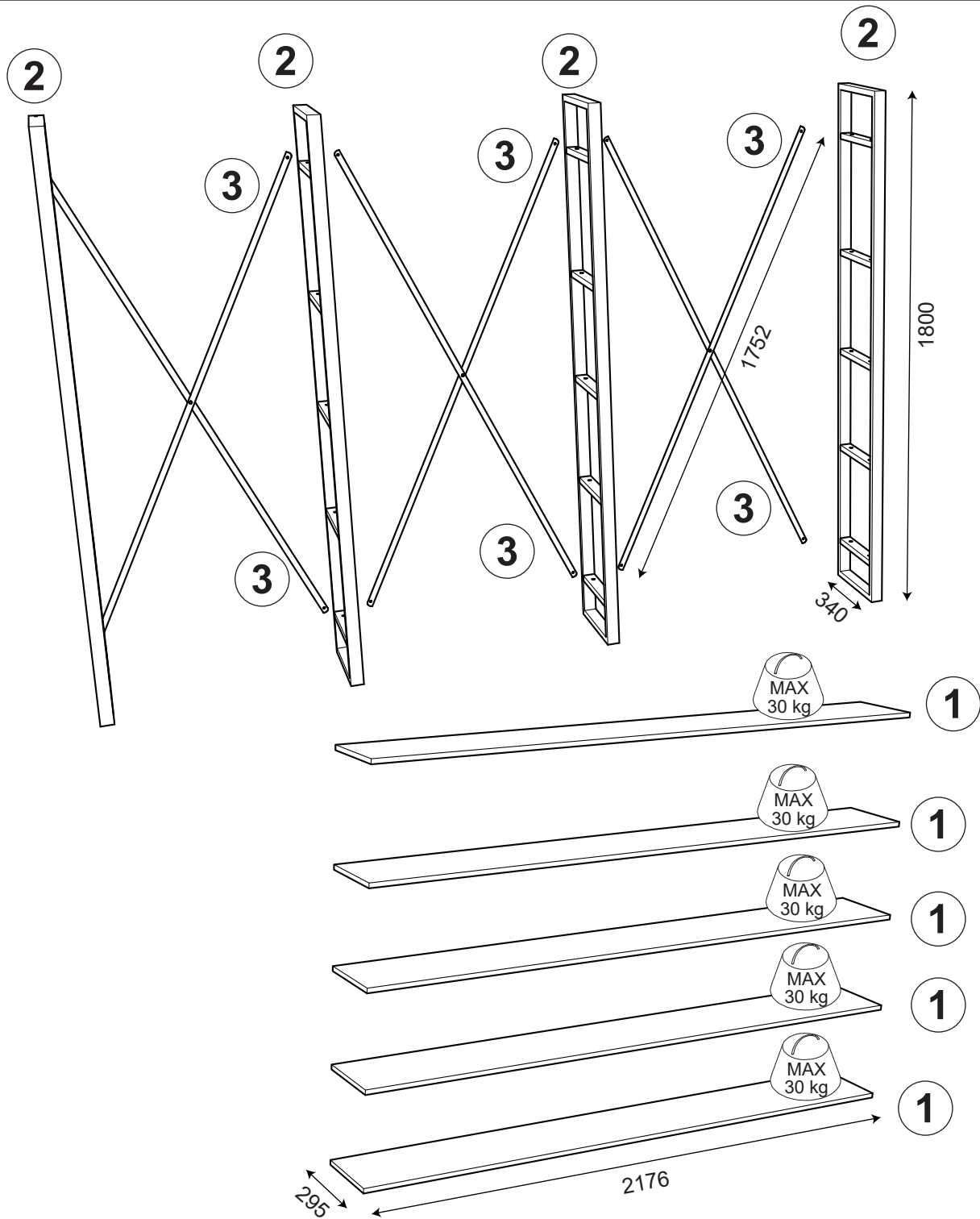

10M<sup>2</sup>



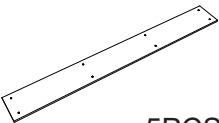
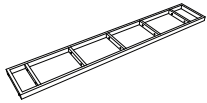

CAJA/COLIS 1/2	CAJA/COLIS 2/2
<p>4 x PIECES 02 6 x PIECES 03</p> <p>Quincaillerie/Hardware</p>	<p>5 x PIECES 01</p> <p>Notice de montage/Assembly instruction</p>

LISTADO DE PIEZAS  
 COMPOSANTS  
 PART LIST

1	2	3	4	5	6
 5PCS	 4PCS	 6PCS			
2176x295x18mm	1800x340x40mm	1752x20mm			

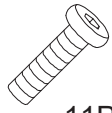
# HERRAJES / QUINCALLERIE / HARDWARE

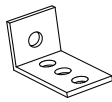
A	B	C	D	E	F
 40PCS	 11PCS	 2PCS	 3PCS	 2PCS	
G	H	I	J	K	L

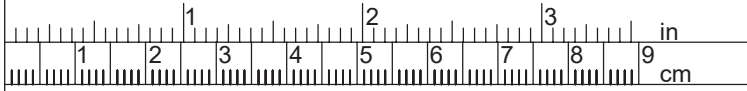
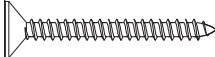
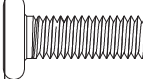
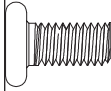
		
A x 40		4 x 30
B x 11		6 x 20
C x 02		6 x 15

## Step 1 / ETAPE 1

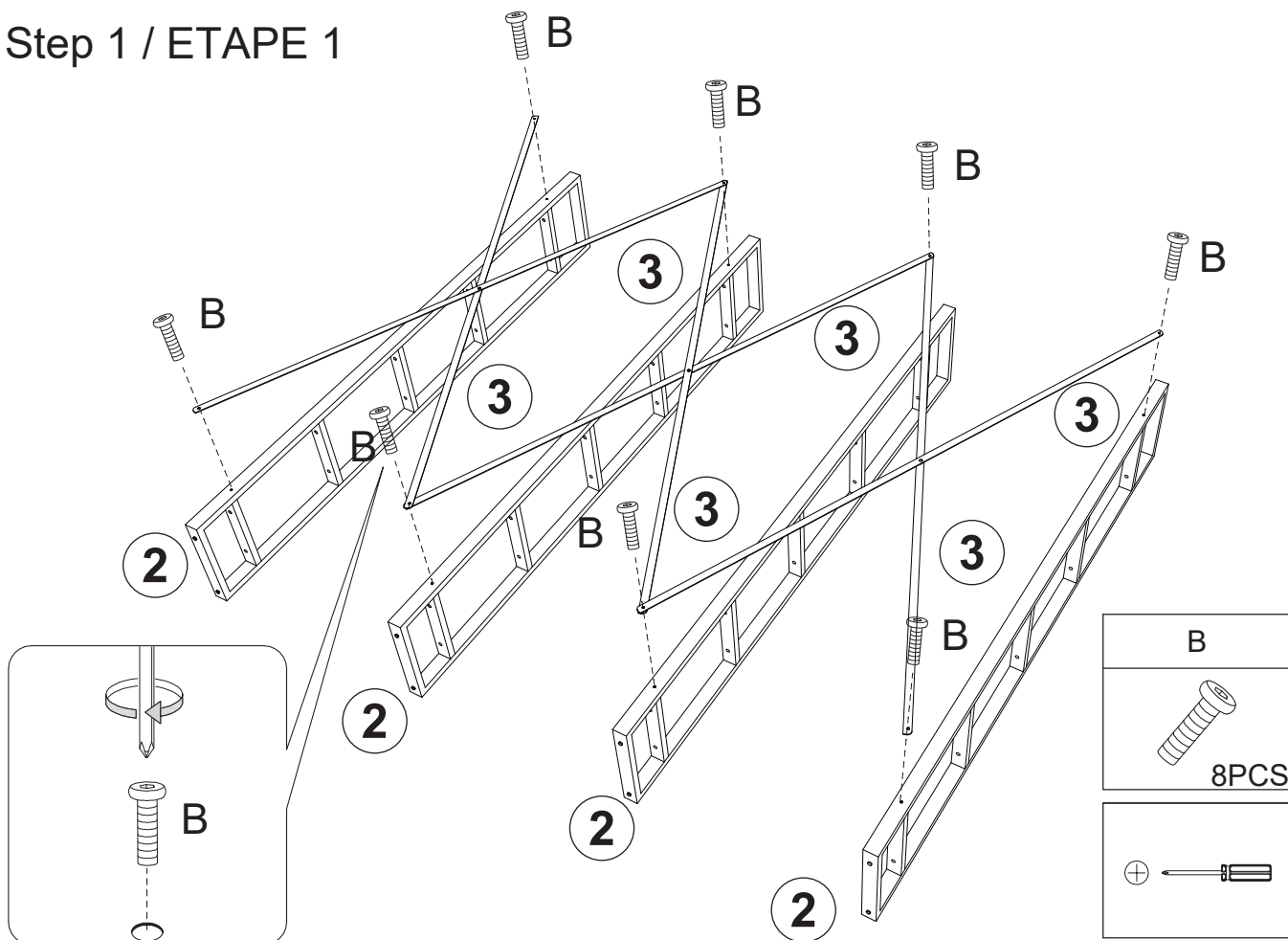

## Step 2 / ETAPE 2

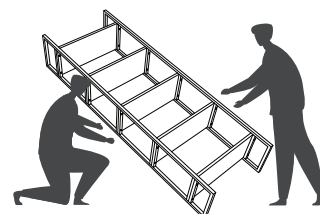
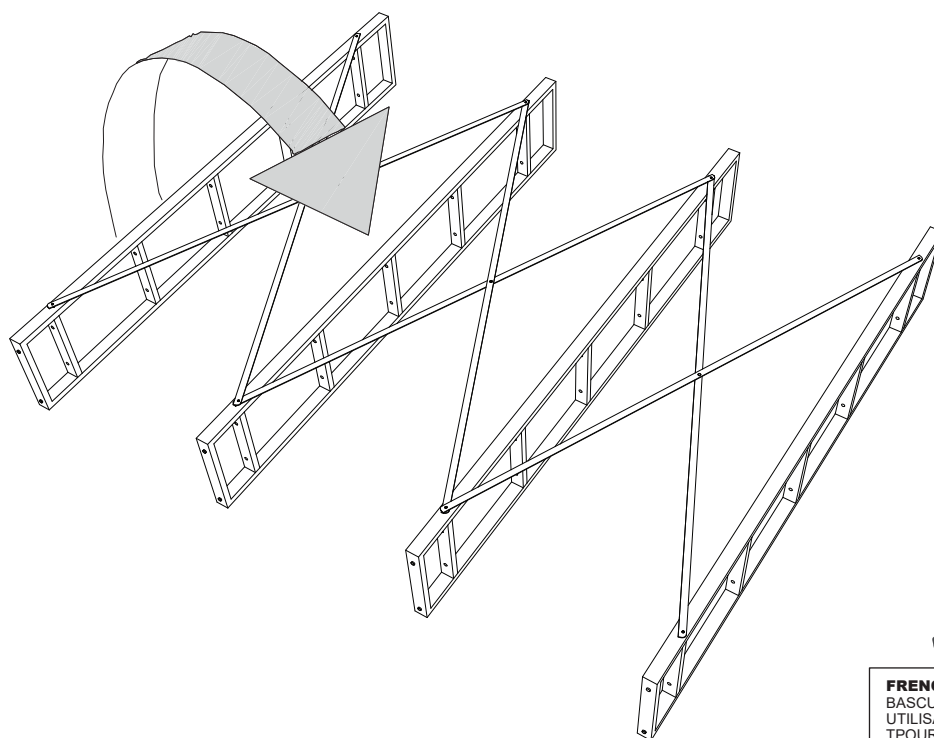

**FRENCH:**  
 BASCULER LE MEUBLE AVEC PRÉCAUTION.  
 UTILISATION D'UNE COUVERTURE RECOMMANDÉE  
 TPOUR NE PAS ABIMER LE MEUBLE.

**ENGLISH:**  
 TURN THE FURNITURE CAREFULL. USE A COVER  
 TO AVOID DAMAGE THE FURNITURE.

**SPANISH:**  
 GIRAR EL MUEBLE CON CUIDADO. UTILICE  
 UN COBERTOR PARA EVITAR DAÑOS EN EL MUEBLE.

### Step 3 / ETAPE 3

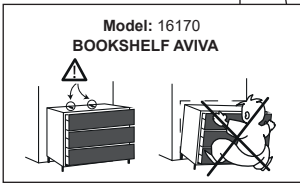
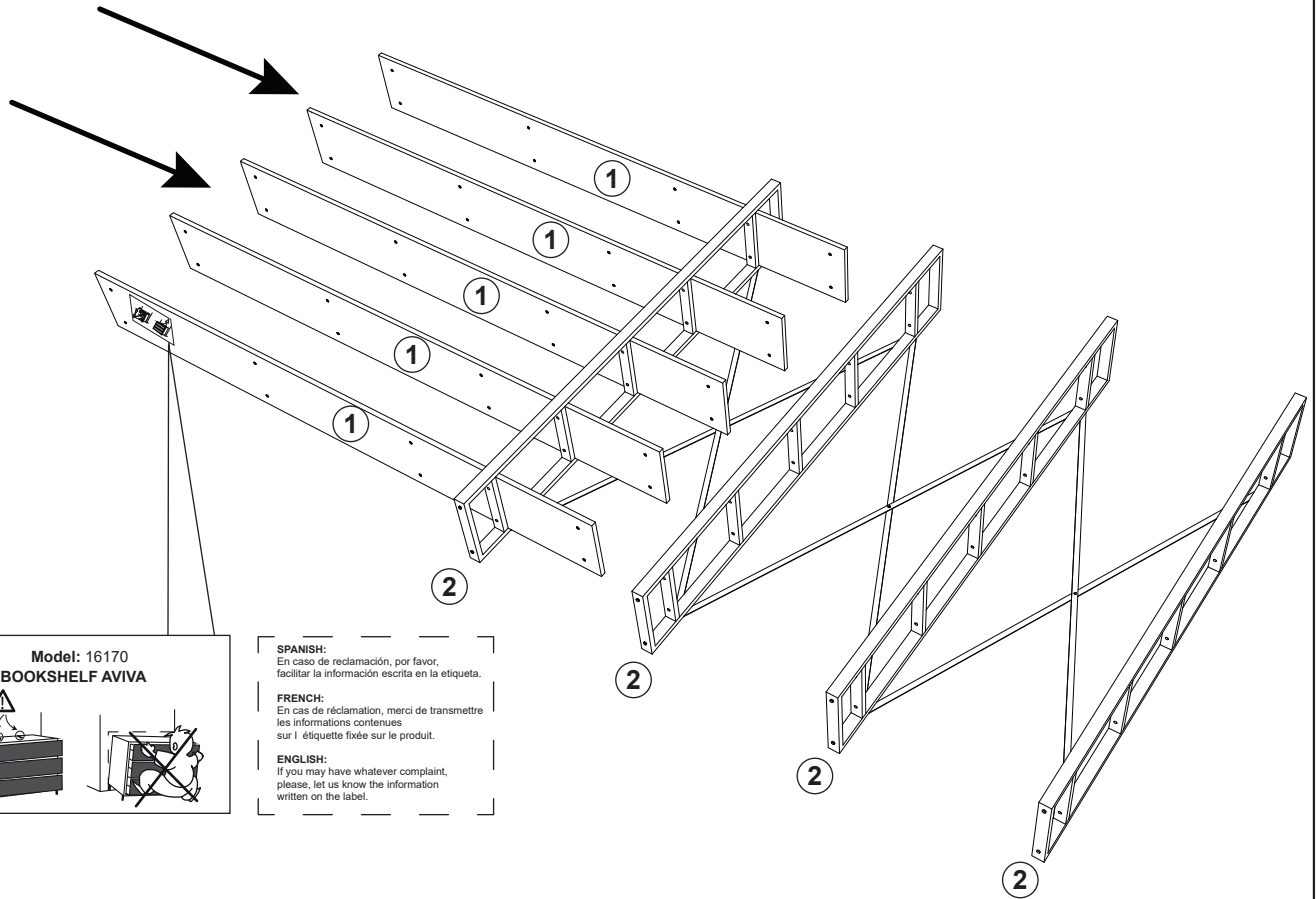

**SPANISH:**  
En caso de reclamación, por favor,  
facilitar la información escrita en la etiqueta.

**FRENCH:**  
En cas de réclamation, merci de transmettre  
les informations contenues  
sur l'étiquette fixée sur le produit.

**ENGLISH:**  
If you may have whatever complaint,  
please, let us know the information  
written on the label.

### Step 4 / ETAPE 4

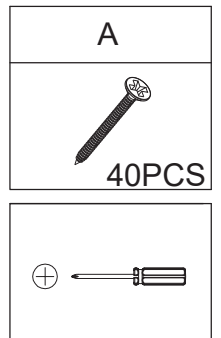
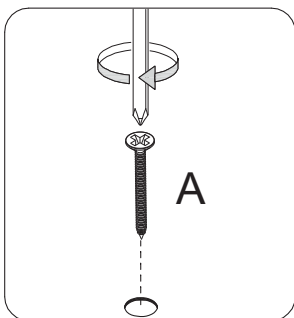
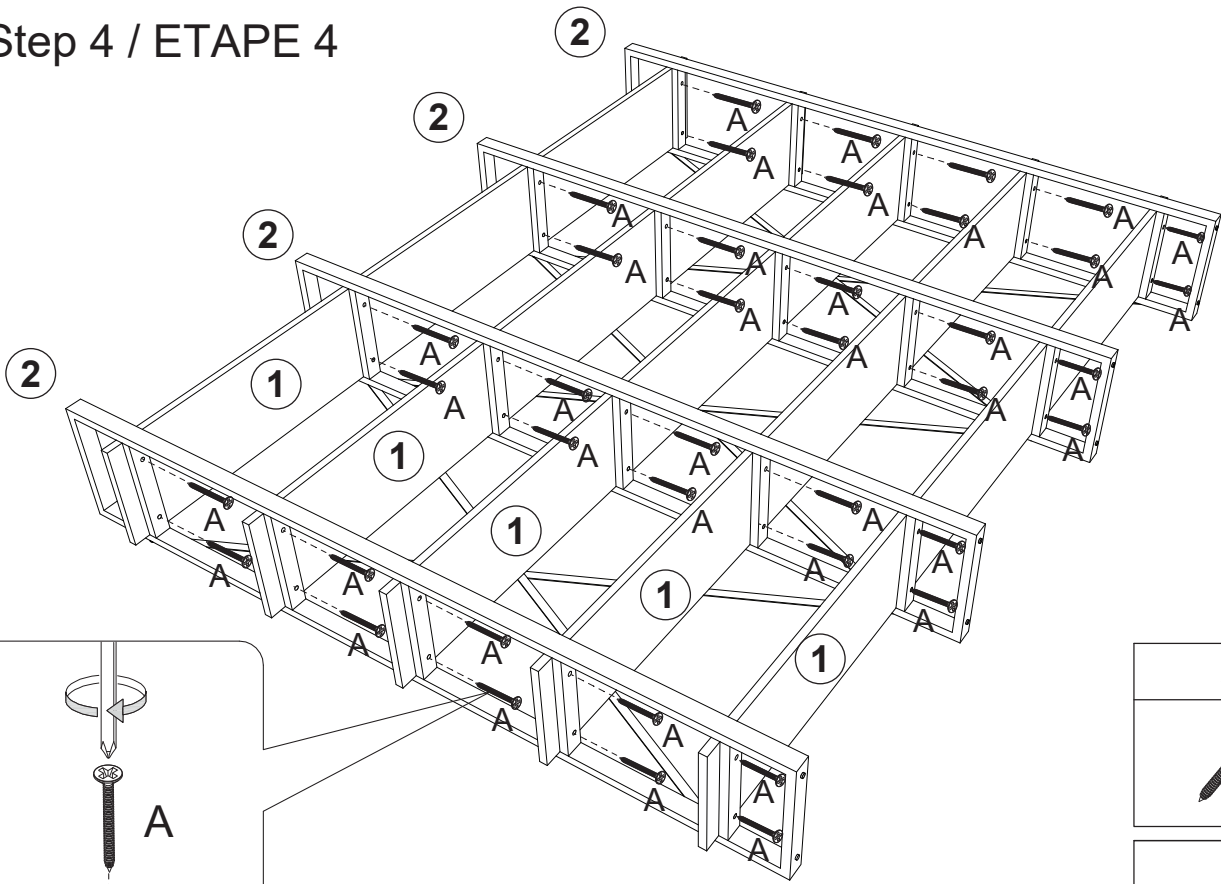

## Step 5 / ETAPE 5

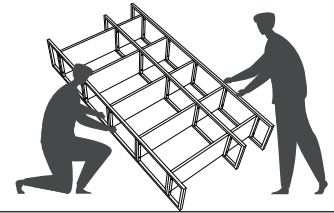
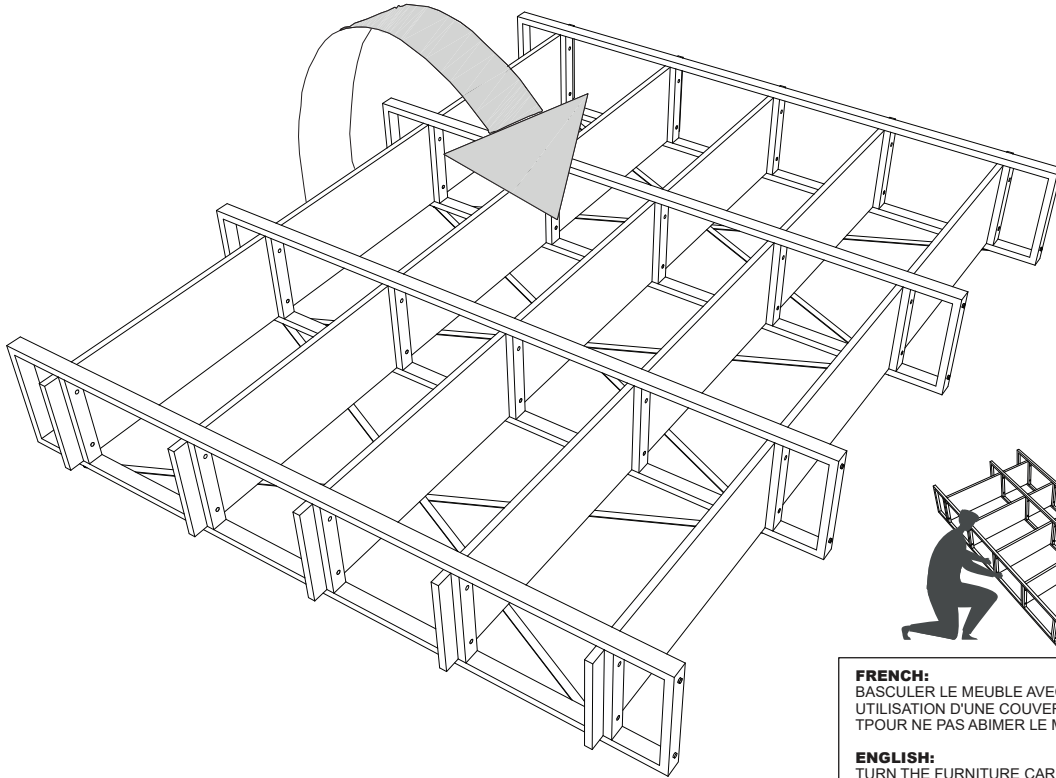

**FRENCH:**  
 BASCULER LE MEUBLE AVEC PRÉCAUTION.  
 UTILISATION D'UNE COUVERTURE RECOMMANDÉE  
 TPOUR NE PAS ABIMER LE MEUBLE.

**ENGLISH:**  
 TURN THE FURNITURE CAREFULL. USE A COVER  
 TO AVOID DAMAGE THE FURNITURE.

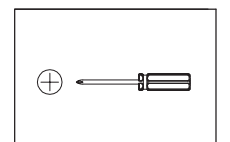
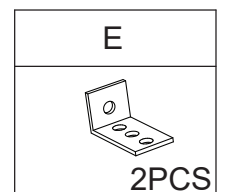
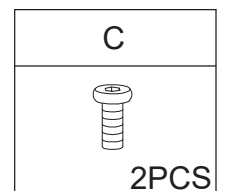
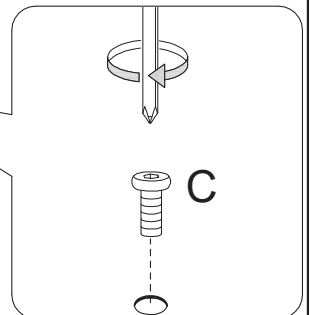
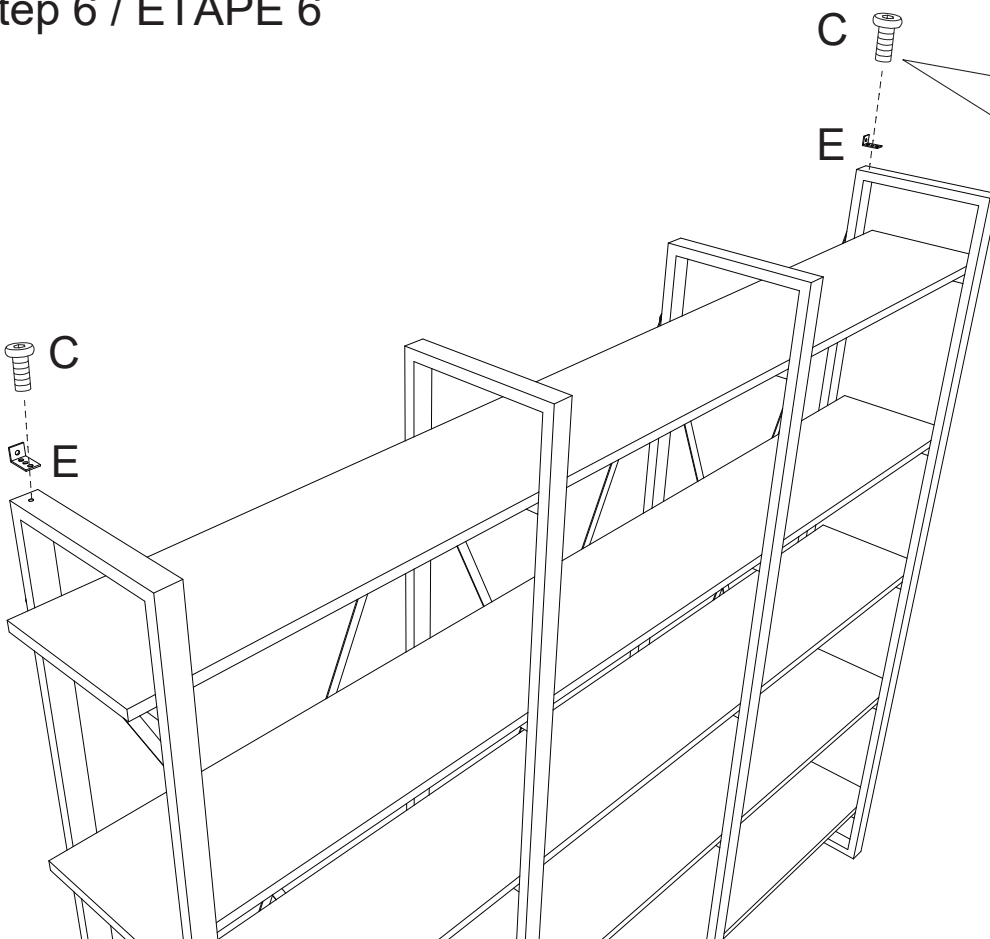

**SPANISH:**  
 GIRAR EL MUEBLE CON CUIDADO.UTILICE  
 UN COBERTOR PARA EVITAR DAÑOS EN EL MUEBLE.

## Step 6 / ETAPE 6

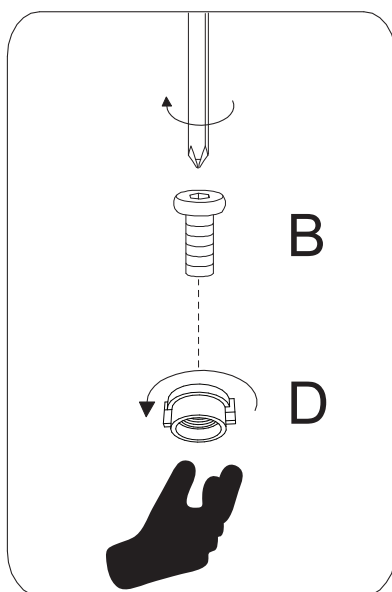
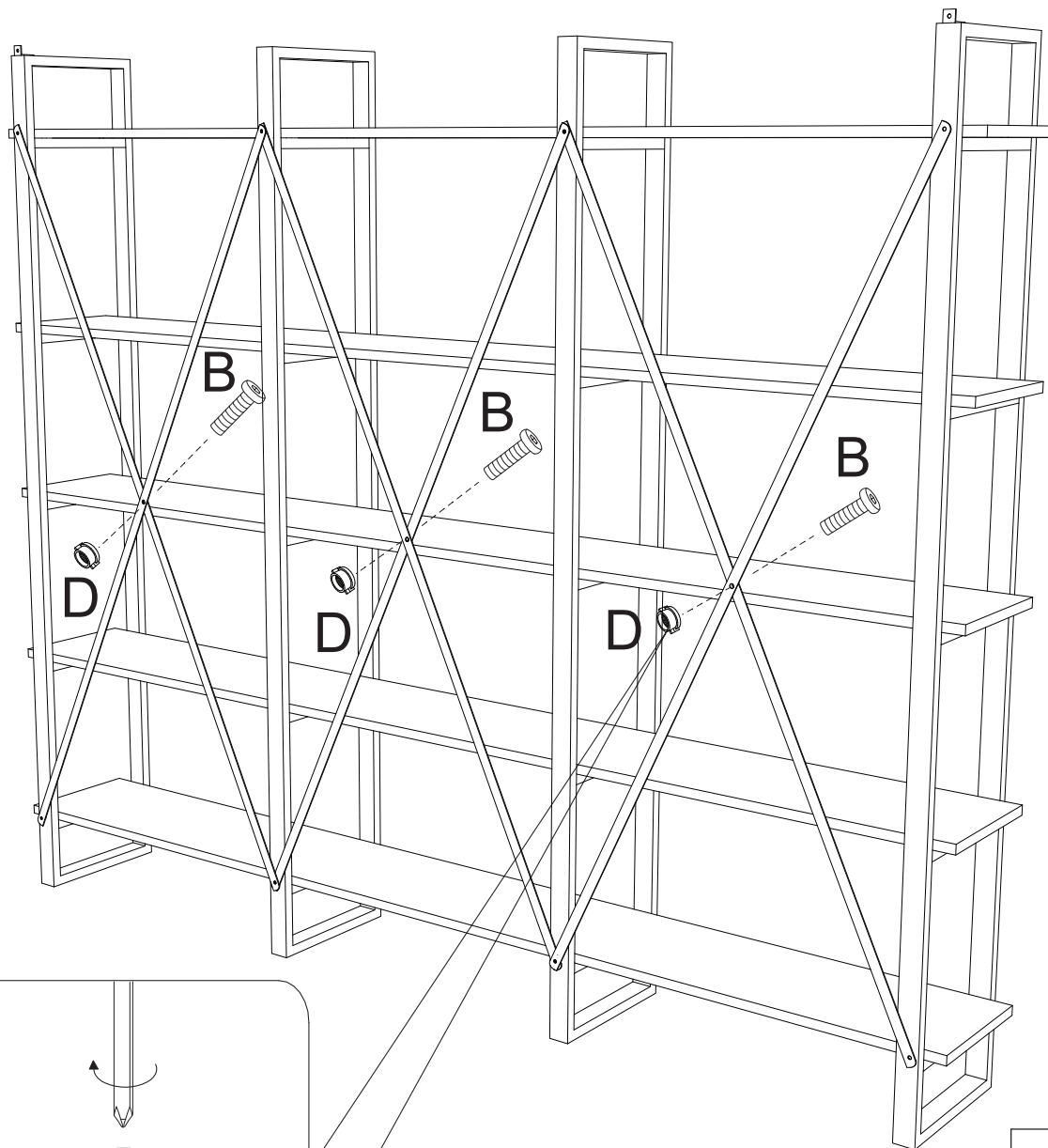

# Step 7 / ETAPE 7



B

3PCS
D

3PCS





## **FIXATION MURALE OBLIGATORIE**

### **UTILISEZ DES VIS ET DES CHEVILLES ADAPTEES A VOS MURS**



Il existe une grande diversité de types de murs ou murs ou cloisons c'est la raison pour laquelle nous ne pouvons vous fournir une quincaillerie adaptée à votre mur. Il est nécessaire d'identifier le type de paroi à laquelle vous allez fixer ce produit afin de vous procurer les fixations appropriées. En cas de besoin, adressez vous à un magasin spécialisé pour conseil



## **OBLIGATORIO FIJAR A LA PARED**

### **UTILICE LOS TORNILLOS Y TACOS ADECUADOS PARA SU MURO**



Existe una gran diversidad de muros y paredes, por esta razón no podemos proporcionarle el herraje adecuado para su pared. Primero, es necesario identificar el tipo de pared para luego utilizar el herraje adecuado. En caso de duda, dirijase a una tienda especializada para mas informacion.



## **OBLIGATORY FIX ON THE WALL**

### **USE SCREWS AND PLUGS SUITABLES FOR YOUR WALL**



Due to the wide diversity of wall or partition types, we cannot provide you with suitable attachment fixtures. To determine which attachment fixtures to use, you will need to identify the type of wall to which you will be fixing this product. If you have whatever doubt, please, go to one specialised shop for further information.

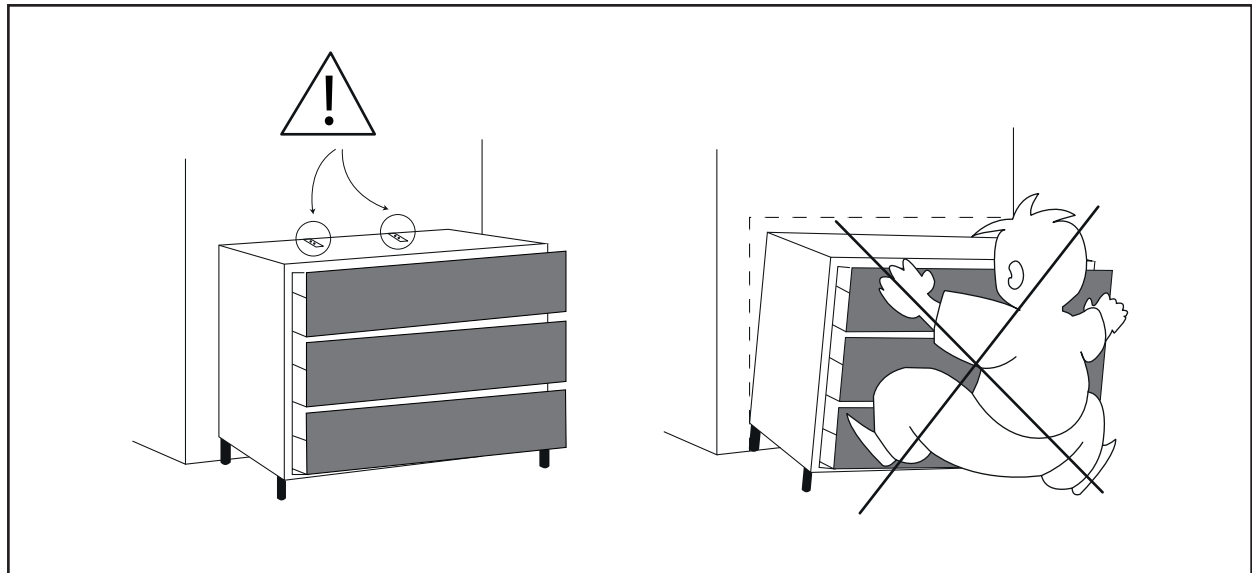

French

**IMPORTANT:** Pour éviter le basculement accidentel du meuble, la fixation du meuble au mur est obligatoire.

La visserie nécessaire pour la jonction mur/meuble, dépendante de la nature du mur, n'est pas fournie. En cas de doute, consulter un spécialiste

English

**IMPORTANT:** To avoid the accidental tip-over of the furniture, the fixing of the furniture on the wall is mandatory.

The needed hardware for the junction wall/furniture, depending of the nature of the wall, is not provided. If any doubt, consult a specialist.

Spanish

**IMPORTANTE:** Para evitar el vuelco accidental de los muebles, es obligatorio fijarlos en la pared.

El tipo de tornillos necesarios para fijar el mueble a la pared, dependen del material de la pared, no se suministran. En caso de duda, consulte a un especialista

Portuguese

**IMPORTANTE:** Para evitar a queda acidental de móveis, é obrigatorio fixá-los na parede. O tipo de parafusos para a fixação de mobiliário na parede, depende do material de parede e não são fornecidos. Em caso de dúvida, consulte um especialista.

Italian

**IMPORTANTE:** Per evitare il ribaltamento accidentale del mobile è obbligatorio il fissaggio a muro.

I tasselli necessari per il collegamento mobile\muro, dipendenti dal tipo di muro, non sono provvisti.

Consultare uno specialista in caso di dubbi

Croatian

**VAŽNO:** Kako bi se izbjeglo slučajno prevrtanje, namještaj je potrebno pričvrstiti na (uza) zid.

Različite vrste zidova zahtijevaju upotrebu različitih vrsta vijaka i tipli. Uvijek koristiti one koji su prikladni za vrstu zidova u domu. Vijci i tiple prodaju se zasebno.

U slučaju bilo kakvih sumnji, obratite se stručnjaku.

German

**WICHTIG :** Um ein versehentliches Kippen des Möbels zu vermeiden, ist die Befestigung an der Wand zwingend vorgeschrieben.



Die benötigten Schrauben zur Wandbefestigung, welche von der Beschaffenheit der Mauer abhängen, sind nicht in der Lieferung enthalten. Wenden Sie sich bitte bei Zweifel an einen Spezialisten.





Il existe une grande diversité de types de murs ou cloisons, c'est la raison pour laquelle nous ne pouvons vous fournir le type exact de fixation. Il est nécessaire d'identifier le type de paroi à laquelle vous allez fixer ce produit afin de vous procurer les fixations appropriées. Voici quelques exemples de fixations conseillées pour:

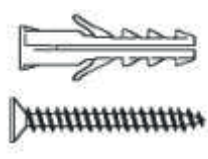

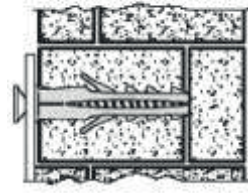
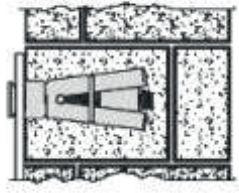
**LES MURS PLEIS**

<p>Cheville nylon "FISCHER"</p> 	<p>Cheville d'ancrage métal</p> 
	

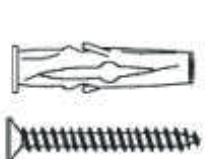
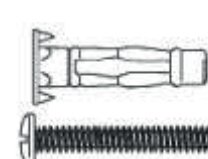
**LES CLOISONS CREUSES**

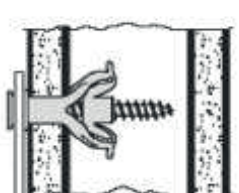
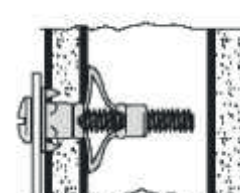
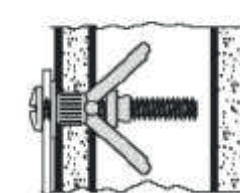
<p>Cheville d'ancrage A ailettes en nylon</p> 	<p>Cheville métallique A expansion</p> 	<p>Cheville "MOLLY"</p> 
		





Utiliser une taille de forêt adaptée à la quincaillerie utilisée et au type de mur.



Es gibt eine Vielzahl verschiedener Arten von Mauern oder Zwischenwänden, und aus diesem Grunde können wir Ihnen den genau entsprechenden Befestigungstyp nicht bereitstellen. Zunächst ist es erforderlich, die exakte Bauart der Wand zu ermitteln, an der Sie dieses Produkt anbringen werden, um die für diese Wand geeigneten Befestigungsmittel im Fachhandel erwerben zu können. Nachfolgend einige Beispiele empfohlener Befestigungen für:

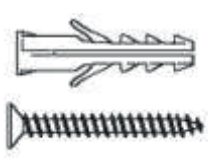

**VOLLWÄNDE**

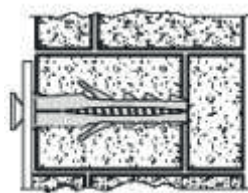
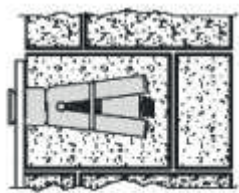
<p>NYLONDÜBEL „FISCHER“</p> 	<p>ANKERDÜBEL AUS METALL</p> 
	

**HOHLWÄNDE**

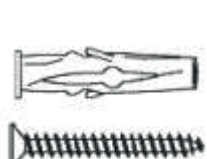
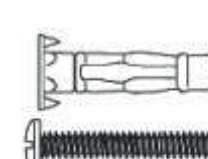
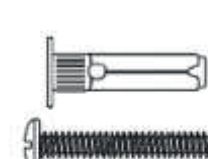
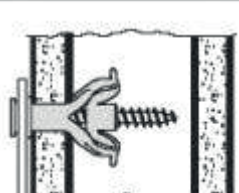
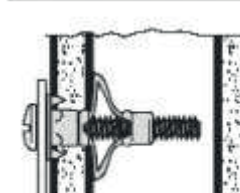
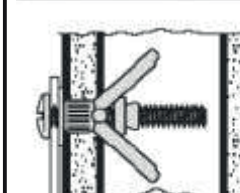



<p>ANKERDÜBEL MIT NYLONFLÜGELN</p> 	<p>SPREIZDÜBEL FÜR VERANKERUNG AUS METALL</p> 	<p>MOLLY-DÜBEL</p> 
		



Bitte verwenden Sie eine für die Eisenwaren und den Wandtyp geeignete Bohrergröße.

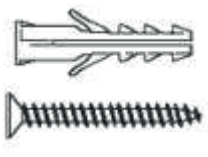
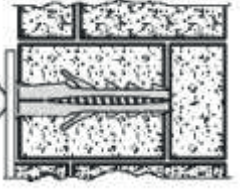
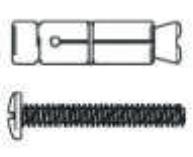
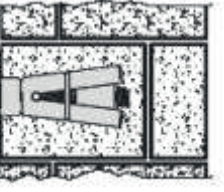
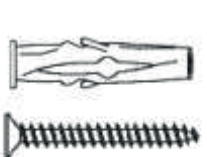
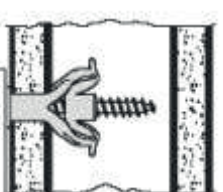

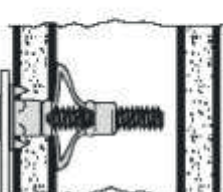
Due to the wide diversity of wall or partition types, we cannot provide you with suitable attachment fixtures . To determine which attachment fixtures to use, you will need to identify the type of wall to which you will be fixing this product. Here are some examples of attachment fixtures recommended for:

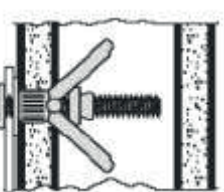

BLIND WALLS		STUDDED WALLS		
<p><b>"FISCHER"</b> Nylon plug</p>  	<p><b>Metal</b> Wall plug</p>  	<p><b>Nylon winged</b> Wall plug</p>  	<p><b>Metal expansion</b> plug</p>  	<p><b>"MOLLY"</b> plug</p>  



Use a drill bit that is compatible in size with the hardware used and the type of wall.

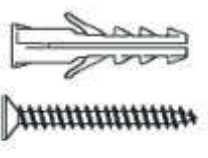
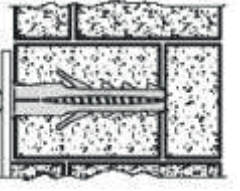
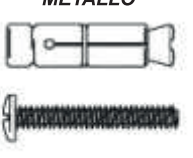
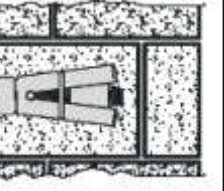
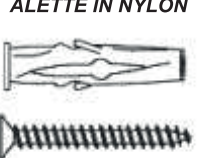
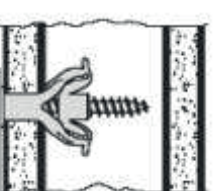
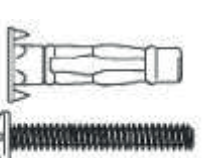
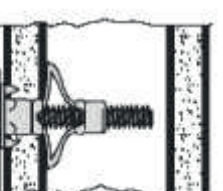

Esiste una gran varietà di tipi di muri o paratie e noi siamo in grado di fornirvi il tipo esatto di fissaggio per ognuno di essi. E' necessario identificare il tipo di parete alla quale intendete fissare questo prodotto in modo da fornirvi i fissaggi più idonei. Ecco qualche esempio di fissaggi consigliati per :

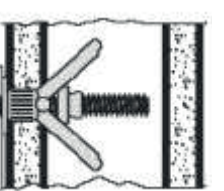
I MURI PIENI		PARATIE CAVE		
<p><b>TASSELLO NYLON</b> "FISCHER"</p>  	<p><b>TASSELLO DI</b> <b>ANCORAGGIO IN</b> <b>METALLO</b></p>  	<p><b>TASSELLO DI</b> <b>ANCORAGGIO AD</b> <b>ALETTE IN NYLON</b></p>  	<p><b>TASSELLO METALLICO</b> <b>AD ESPANSIONE</b></p>  	<p><b>TASSELLO</b> "MOLLY"</p>  



Utilizzare una punta di trapano adatta agli utensili utilizzati e al tipo di muro.

**FRANÇAIS:**

Après assemblage de ce produit, il est conseillé d'aérer régulièrement la pièce pendant quelques jours.

**ESPAÑOL:**

Después de montar este producto, es aconsejable ventilar la habitación frecuentemente, durante algunos días.

**ENGLISH:**

After assembling this product, it is recommended to regularly ventilate the room for a few days.



## FRANCAIS - SUISSE

### CONSEILS DE MONTAGE :

- 1 > BIEN ETUDIER LA NOTICE DE MONTAGE.
- 2 > REPEREZ LES PIECES CONSTITUANT VOTRE MEUBLE.
- 3 > REGROUPEZ ET CONTROLEZ LA QUINCAILLERIE.
- 4 > MUNISSEZ-VOUS DE L'OUTILLAGE NECESSAIRE.
- 5 > AMENAGEZ-VOUS UNE ZONE DE MONTAGE.
- 6 > PROCEDEZ AU MONTAGE.



**NE JAMAIS FORCER LES ASSEMBLAGES.  
RESSERREZ LES VIS APRES QUELQUES TEMPS D'USAGE.  
GARDER VOTRE NOTICE DE MONTAGE, SI UNE PIECE  
VENAIT A MANQUER, ELLE SERAIT LE PLUS CLAIR  
MOYEN DE COMMUNIQUER AVEC VOTRE MAGASIN.**

### CONSEILS D'ENTRETIEN :

- 1 > DÉPOUSSIÉREZ SOIGNEUSEMENT.
- 2 > UTILISEZ UN CHIFFON SEC.



**- NE JAMAIS UTILISER  
DE PRODUITS ABRASIFS:  
POUDRE, LAINE D'ACIER, SOLVANTS.  
- NE PAS MOUILLER**

	PAPIER DECOR	SURFACES STRATIFIÉES	SURFACES LAQUÉES	BOIS VERNIS	TEXTILE CUIR
EAU SAVONNEUSE (SAVON NEUTRE)	○	○	○	○	○
EAU ADDITIO NÉ		○	○		
ENTRETIEN SPÉCIFIQUE FABRICANT					○

## DEUTSCH - SCHWEIZ

### MONTAGE ANLEITUNG:

- 1 > DIE MONTAGEANLEITUNG SORGFÄLTIG DURCHLESEN.
- 2 > DIE EINZELTEILE DES MÖBELSTÜCKS ERMITTELN.
- 3 > DIE BESCHLÄGE ZUSAMMENLEGEN UND PRÜFEN.
- 4 > DAS NOTWENDIGE WERKZEUG ZURECHTLEGEN.
- 5 > EINEN MONTAGEBEREICH FREIMACHEN.
- 6 > DAS MÖBELSTÜCK ZUSAMMENBAUEN.



**NIEMALS DIE VERBINDUNGEN ZU STARK ANZIEHEN.  
DIE SCHRAUBEN NACH EINIGER ZEIT DES GEBRAUCHS  
ERNEUT FESTZIEHEN. DIE MONTAGEANLEITUNG  
GUT AUFBEWAHREN: SOLLTE EIN TEIL FEHLEN, IST SIE DAS  
BESTE VERSTÄNDIGUNGSMITTEL MIT IHREM GESCHÄFT.**

### PFLEGEHINWEISE :

- 1 > SORGFÄLTIG ENTSTAUBEN.
- 2 > VERWENDEN SIE EIN TROCKENES TUCH.



**- BENUTZEN SIE KEINE  
SCHEUERMITTEL WIE PULVER,  
STAHLWOLLE, LÖSUNGSMITTEL.  
- KEIN WASSER VERWENDEN.**

	DEKORPAPIER	OBERFLÄCHE LAMINAT	OBERFLÄCHE LACK	LACKIERTEM HOLZ	TEXUL LEDER
SEIFENLAUGE (NEUTRALSEIFE)	○	○	○	○	○
WASSER MIT HAUSHALTSRFINIGER		○	○		
PRODUZENT SPEZIFISCHER UNTERHALT					○

## ITALIANO - SVIZZERA

### CONSIGLI DI MONTAGGIO

- 1 > STUDIARE BENE LE ISTRUZIONI DI MONTAGGIO.
- 2 > PRENDERE CONOSCENZA DEI PEZZI CHE COSTITUISCONO IL MOBILE.
- 3 > RAGGRUPPARE E CONTROLLARE LA FERRAMENTA.
- 4 > MUNIRSI DEGLI UTENSILI NECESSARI.
- 5 > PREPARARE UNA ZONA DI MONTAGGIO.
- 6 > PROCEDERE AL MONTAGGIO.



**NON FORZARE MAI GLI ASSEMBLAGGI  
RISTRINGERE LE VITI DOPO UN PERIODO D'USO  
CONSERVARE QUESTE ISTRUZIONI DI MONTAGGIO,  
SE UN PEZZO VENISSE A MANCARE SAREBBE IL MIGLIORE  
MEZZO DI COMUNICAZIONE CON IL RIVENDITORE**

### CONSIGLI PER LA MANUTENZIONE :

- 1 > SPOLVERATE ACCURATAMENLE.
- 2 > USARE UN PANNINO ASCIUTTO.



**- NON UTILIZZARE MAI PRODOTTI  
ABRASIVI: POLVERE,  
LANA DI ACCIAIO, SOLVENTI.  
- NON BAGNARE.**

	CARTA	SUPERFICIE STRATIFICATE	SUPERFICIE LACCATE	LACCATE EGNO VERNICIATO	TESSILE CUIRO
ACQUA CON SAPONE (SAPONE NEUTRO)	○	○	○	○	○
ACQUA CON DETERSIVO SAN MARC		○	○		
MANUTENZIONE SPECIFICA PRODUTTORE					○

## PORTUGUÊS

### CONSELHOS DE MONTAGEM:

- 1 > ESTUDE BEM AS INSTRUÇÕES DE MONTAGEM.
- 2 > REUNA AS PEÇAS QUE CONSTITUEM O SEU MÓVEL.
- 3 > REAGRUPE AS FERRAGENS.
- 4 > EQUIPE-SE COM AS FERRAMENTAS NECESSÁRIAS.
- 5 > PREPARE UMA ÁREA PARA A MONTAGEM.
- 6 > INICIE A MONTAGEM.



**NUNCA FORÇAR OS ENCAIXES.  
REAPERTAR OS PARAFUSOS APÓS UM TEMPO DE UTILIZAÇÃO.  
GUARDAR AS INSTRUÇÕES DE MONTAGEM.  
CASO FALTE ALGUMA PEÇA, O MAIS ACONSELHÁVEL  
É CONTATAR O REVENDEDOR.**

### CONSELHOS PARA A MANUTENÇÃO :

- 1 > ELIMINAR BEM O PÓ.
- 2 > USAR PANO SECO.



**- NUNCA UTILIZAR PRODUTOS  
ABRASIVOS: SAPONÁCEOS,  
LÃ DE AÇO, SOLVENTES.  
- NÃO MOLHAR .**

	ACABAMENTO IMITAÇÃO	SUPERFÍCIES ESTRATIFICADAS	SUPERFÍCIES LACADAS	MADEIRA ENVERNIZADA	TEXTEIS PELES
ÁGUA COM SABÃO (SABÃO NEUTRO)	○	○	○	○	○
ÁGUA COM DETERGENTE		○	○		
INSTRUÇÕES ESPECÍFICAS DO FABRICANTE					○

## ESPAÑOL

### CONSEJOS PARA EL MONTAJE:

- 1 > ESTUDIE ATENTAMENTE EL MANUAL DE MONTAJE.
- 2 > LOCALICE LAS PIEZAS QUE CONSTITUYEN SU MUEBLE.
- 3 > REUNA Y CONTROLE LOS TORNILLOS.
- 4 > EQUIPE-SE DE LAS HERRAMIENTAS NECESARIAS.
- 5 > PREPARE UNA ZONA DE MONTAJE.
- 6 > REALICE EL MONTAJE.



**NO FUERCE NUNCA EN LAS UNIONES. APRIETE LOS  
TORNILLOS DESPUES DE CIERTO TIEMPO DE UTILIZACION  
CONSERVE SU MANUAL DE MONTAJE,  
SI FALTARA UNA PIEZA, SERIA LA MANERA  
MAS FACIL DE COMUNICAR CON LA TIENDA.**

### CONSEJOS PARA EL MANTENIMIENTO:

- 1 > DESPOLVOREAR CULDADOSAMENTE.
- 2 > UTILICE UN PAÑO SECO.



**- NO USE NUNCA PRODUCTOS  
ABRASIVOS TALES COMO:  
POLVO DE LIMPIAR,  
LANA DE ACERO, SOLVENTES.  
- NO MOJAR.**

	PAPEL DE DECORACION	SUPERFICIE ESTRATIFICADAS	SUPERFICIE MAQUEADAS	MADERA BARNIZADA	TEXTIL/ CUERO
AGUA Y JABON (JABON NEUTRO)	○	○	○	○	○
AGUA COM DETERGENTE		○	○		
MANTENIMIENTO ESPECIFICO DEL FABRICANTE					○

## HRVATSKA

### UPUTE ZA MONTAŽU:

- 1 > PAŽLJIVO PROČITAJTE UPUTE ZA MONTAŽU.
- 2 > PRIPREMITE SVE DIJELOVE NAMJEŠTAJA.
- 3 > PRIKUPITE I PROVJERITE OKOVE ZA MONTAŽU.
- 4 > PRIPREMITE POTREBAN ALAT.
- 5 > PRIPREMITE PROSTOR ZA MONTAŽU.
- 6 > POČNITE MONTIRATI.



**NEMOJTE UPOTREBLJAVATI SILU PRILIKOM SKLAPANJA  
NAKON NEKOG VREMENA PONOVRNO PRITEGNITE VIJKE  
ČUVAJTE UPUTE ZA MONTAŽU  
U SLUČAJU NEDOSTATKA NEKOG DIJELA NAJBOLJE ĆE BITI DA  
DA KONTAKIRATE PRODAJNO MJESTO.**

### UPUTE ZA ODRŽAVANJE :

- 1 > PAŽLJIVO OBRISATI PRAŠINU.
- 2 > KORISTITE SUHU KRPU.



**- ZABRANJENA JE UPOTREBA  
KEMIKALIJA ILI BILO KAKVIH  
POMOĆNIH SREDSTAVA ZA RIBANJE  
JAKIH SREDSTAVA ZA ČIŠĆENJE ILI  
ČELIČNE VUNE  
-NE MOKRA.**

	PAPIR	LAMINAT	LAK	DRVO	TEKSTIL/ KOŽA
OTPINA SAPUNA	○	○	○	○	○
OTPINA DETERDŽENTA		○	○		
NAMJENSKA SREDSTVA					○

## TÜRÇE

### MONTAJ TALIMATLARI:

- 1 > MONTAJ TANITIM YAZISINI DIKKATLICE OKUYUNUZ .
- 2 > MOBILİYANIZI OLUŞTURAN PARÇALARI İŞARETLEYİNİZ.
- 3 > HIRDAVATLA İLGİLİ PARÇALARI BİR ARAYA TOPLAYIP; KONTROL EDİNİZ.
- 4 > GEREKEN ARAÇ VE GEREÇİ TEDARİK EDİNİZ.
- 5 > (KENDİNİZE) BİR MONTAJ ALANI EDİNİNİZ.
- 6 > MONTE ETMEYE BAŞLAYINIZ.



**MONTAJLARI ZORLAMAYINIZ.**  
**BİRKAÇ KULLANIMDAN SONRA VIDALARI SIKIŞTIRINIZ.**  
**BİR PARÇANIN KAYBOLMASI DURUMUNDA MAGAZANIZLADAHA**  
**KOLAY İLETİŞİME GEÇEBİLMENİZ İÇİN MONTAJ KULLANIM**  
**TALIMATINIZI SAKLAYINIZ.**

### BAKIM TALIMATLARI:

- 1 > TOZUNU DIKKATLICE ALINIZ.
- 2 > YUMUŞAK BİR BEZİ TEMİZ SU VE AZ MİKTARDA SABUNLA(DETERJAN) NEMLENDİRİNİZ.



**ASLA AŞINDIRICI ÜRÜNLER**  
**KULLANMAYINIZ : ÇELİK YÜNÜ,**  
**SOLVENT...  
BOL SUYLA YIKAMAYINIZ.**

	SÜS KAGIDI	KATMAN YÜZEY	LAKE YÜZEY	CILALI TAHTA	TEKSTİL DERİ
SABUNLU SU (NOTR SABUN)	○	○	○	○	○
DETERJAN KATILMIŞ SU		○	○		
ÜRETİCİYE ÖZGÜ BAKIM					○

## ENGLISH

### ASSEMBLY ADVICE :

- 1 > CAREFULLY READ THE ASSEMBLY INSTRUCTION.
- 2 > IDENTIFY THE COMPONENTS OF THE FURNITURE.
- 3 > GROUP AND CHECK THE HARDWARE.
- 4 > USE THE REQUIRED TOOLS.
- 5 > CREATE AN ASSEMBLY ZONE.
- 6 > MAKE THE ASSEMBLY.



**NEVER FORCE THE CONNECTIONS.**  
**RE-TIGHTEN THE SCREWS AFTER FEW DAYS.**  
**PLEASE RETAIN THE AI LEAFLET FOR FUTURE REFERENCE,**  
**THE AI CONTAINS INFORMATION WHEN CLAIMING**  
**FOR MISSING PARTS.**

### CLEANING ADVICE:

- 1 > CAREFULLY REMOVE THE DUST.
- 2 > USE A SOFT, CLEAN DAMP CLOTH WITH SOAPY WATER.



**NEVER USE ABRASIVE PRODUCTS**  
**OR SOLVENTS.**  
**DO NOT APPLY EXCESSIVE PRESSURE**  
**WHEN USING THE DAMP CLOTH.**

	PAPER DECOR	LAMINATED SURFACES	LACQUERED SURFACE	VARNISHED WOOD	LEATHER TEXTILE
SOAPY WATER (NEUTRAL SOAP)	○	○	○	○	○
WATER WITH DETERGENT		○	○		
SPECIFIC SUPPLIER CLEANING					○



**LE TRI**  
**+ FACILE**



FR

**Donnez ou recyclez**  
**vos meubles.**



<https://quefairedemesdechets.fr>