

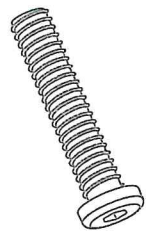

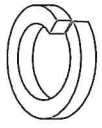



<p>A x 8</p>  <p>M8x65 mm</p>	<p>B x 8</p>  <p>Ø8 mm</p>	<p>C x 8</p>  <p>Ø8/Ø16 mm</p>	<p>D x 1</p>  <p>5 mm</p>	<p>E x 4</p>  <p>Ø35 mm</p>
--	---	---	--	--

1

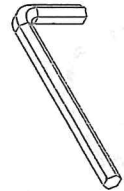
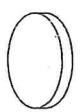
A x 8  M8x65 mm	B x 8  Ø8 mm	C x 8  Ø8/Ø16 mm	D x 1  5 mm	E x 4  Ø35 mm
--	---	---	--	--

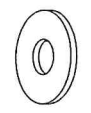
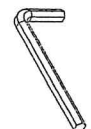

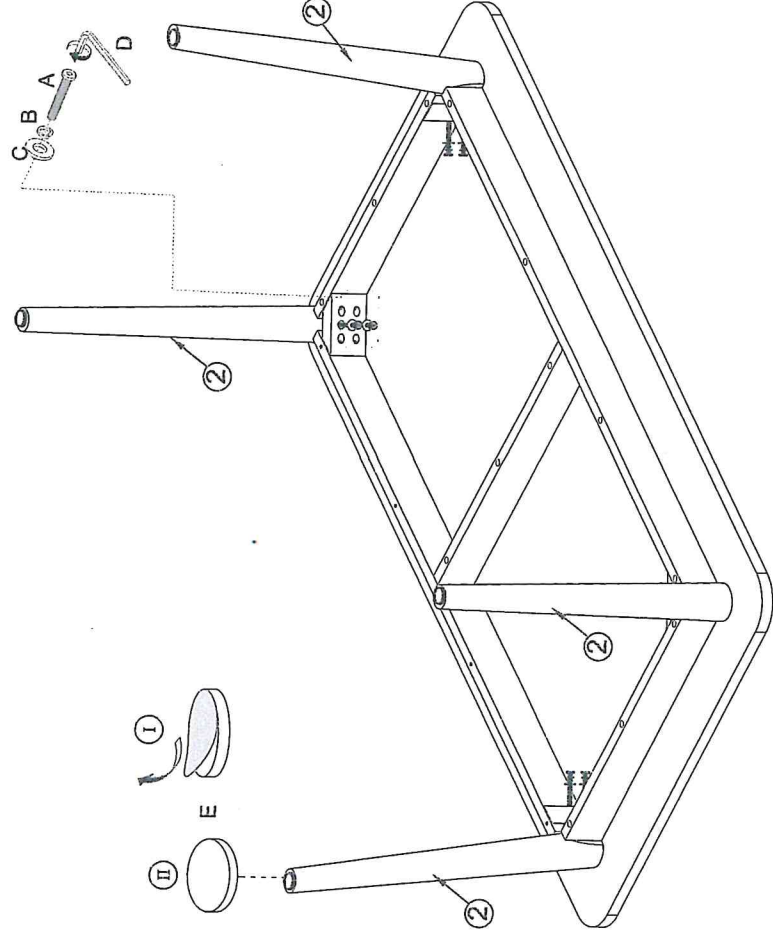
2

